

# **RADON RETEST REPORT**

**May 1st, 2023**

**EIS Job No. 2023013**

**Prepared For:**

**Eddyville Charter School  
C/O Danny Wheeler, Facility Director  
1 Eddyville School Rd,  
Eddyville, OR 97343  
Phone: (541) 875-2942  
E-mail: danny.wheeler@lincoln.k12.or.us**

**Prepared By:**

**Environmental Inspection Services Pro LLC  
Matthew C. Spear, Environmental Professional  
430 N First St.  
Carlton, OR 97111  
Cell: (503) 944-9818  
E-mail: charles\_a\_spear@yahoo.com**



**EIS**  
ENVIRONMENTAL INSPECTION SERVICES PRO LLC



## TABLE OF CONTENTS

<u>DESCRIPTION</u>	<u>PAGE NO.</u>
1.0 EXECUTIVE SUMMARY.....	1
2.0 RADON ENVIRONMENTAL RISK.....	2
3.0 RADON HEALTH EFFECTS.....	2-3
4.0 RADON DESCRIPTION.....	3
5.0 RADON CHARACTERISTICS.....	3
6.0 RADON TESTING ACTIVITY.....	3-4
7.0 RADON TEST RESULT TABLE.....	4
8.0 RADON MEASUREMENT RISK ASSESSMENT.....	4-5
9.0 RADON LABORATORY ANALYSIS.....	5
10.0 QUALITY ASSURANCE & CONTROL.....	5-6
11.0 FINDINGS, OPINIONS, & CONCLUSIONS.....	6
12.0 LIMITATIONS.....	6

## APPENDIXES

RADON ANALYTICAL TEST RESULTS. ....	APPENDIX 1.0
SAMPLE LOCATIONS.....	APPENDIX 2.0
RADON REGULATION.....	APPENDIX 3.0

## **1.0 EXECUTIVE SUMMARY**

Radon Retest Report

May 1st, 2023

### **Sampling Location(s):**

(Eddyville Charter School)  
1 Eddyville School Rd,  
Eddyville, OR 97343  
Lincoln County

Eddyville Charter School  
C/O Danny Wheeler, Facility Director

Dear Mr. Danny Wheeler,

This letter summarizes the finding of a short-term (48-96 hour) radon retest sampling test episode conducted at the subject property(s) for the Eddyville Charter School listed above between Friday, April 21st, 2023, and Monday, April 24th, 2023. The eight (8) radon samplers were sent to PRO-LAB on Monday, April 24th, 2023, and the results were reported to EIS on Friday, April 28th, 2023. The radon sampling episode was conducted by Matthew C. Spear, field representative of Environmental Inspection Services Pro LLC (EIS) with an escort through the facilities listed above. Of these eight (8) samples, none were above the 4pCi/L action limit, based on the short-term radon results reported by PRO-LAB. Existing ventilation and mitigation systems have adequately resolved any previous elevated radon levels based on these results.

EPA notes there is no safe level of radon, but no action is required for results under 4 pCi/L. If there are questions concerning the radon testing at the educational school district, please initially contact my cell at (503) 680-6398.

Respectfully submitted,  
Environmental Inspection Services Pro LLC  
Matthew C. Spear, Environmental Professional

A handwritten signature in black ink that reads 'Matthew C. Spear'.

## **2.0 RADON ENVIRONMENTAL RISK**

The U.S Environmental Protection Agency (EPA) and other major national and international scientific organizations have concluded that radon is a human carcinogen and poses a serious environmental health problem. The EPA recommends that schools take action to reduce the level of radon concentration if radon concentration levels are 4 pCi/L or higher.

The U.S Surgeon General has warned about the health risk from exposure to radon in indoor air. The surgeon general has urged Americans to test their homes because radon is the leading cause of lung cancer for non-smokers in the United States breathing in radon over prolonged periods can present a significant health risk. The USEPA has estimated that approximately 21,000 lung cancer-related deaths occur annually with an estimated 275 lung cancer deaths annually in Oregon.

The US EPA stated “Any exposure has some risk of causing lung cancer. The lower the radon risk level in your home, the lower your family’s risk of lung cancer.” The EPA has noted that depending on your geographic location the radon levels of air you breathe outside the home may be as high as 0.74 pCi./L. The national average of outside radon levels is 0.4 pCi/L and it has been estimated by The National Academy of Sciences that outdoor radon levels cause approximately 800 of the 21,000 radon-induced lung cancer deaths in the US each year.

Radon Act 51 passed by Congress set the national outdoor level of radon gas (0.4pCi/L) as the target radon level for indoor radon levels. Unfortunately, two-thirds of all homes exceeded this level. The USEPA was tasked with setting practical guidelines and recommendations for the nation. The USEPA thereby set a practical level of 4pCi/L as an action level for radon.

## **3.0 RADON HEALTH EFFECTS**

Radon is a known human carcinogen. Prolonged exposure to elevated radon concentrations does cause an increased risk of lung cancer. The precise magnitude of radon health risks is uncertain, and research continues regarding these health risks. The EPA has estimated that radon may cause nearly 14,000 lung cancer deaths in the United States each year. However, this number could range from nearly 7,000 to 30,000 deaths per year. The U.S. Surgeon General has warned that radon is the second-leading cause of lung cancer deaths. The individual risks from radon exposure have been attributed to three factors: the level of radon, the duration of radon exposure, and the individual smoking habits. The risk of death from lung cancer has been determined to be much higher for smokers than non-smokers.

The EPA has noted that the home is to be the most likely significant source of radon exposure. Additionally, the EPA has also noted that the second largest potential contributor to radon exposure is likely to be schools. The EPA has recommended that school buildings be tested for radon. In 1989 and 1990, the EPA conducted the School Protocol Development Study nationwide to examine further how best to conduct radon measurements in schools.

#### **4.0 RADON DESCRIPTION**

Radon is a gas, and the radon decay products are referred to as solid particles (progeny). The radon particles may become suspended in the air when they are formed. Some particles “plate out” (attach) to surfaces as aerosols, dust, and/or smoke particle in the air. The inhalation of the particles has been attributed to lung tissue damage and may affect DNA.

Radon gas is an extremely toxic, chemically inert, odorless, colorless, and tasteless naturally-occurring radioactive element having the symbol Rn. Radon has the atomic number 86; an atomic weight of 222; a melting point of -71 degrees Celsius; a boiling point of -62 degrees; and 18 radioactive isotopes. It is derived from the radioactive decay of radium and is used in cancer treatment; as a tracer in leak detection; in radiology.

#### **5.0 RADON CHARACTERISTICS**

The concentrations of radon in a building are dependent on factors including the concentration of uranium and radium in the soil; the type of underlying geology; soil permeability; available migration pathways such as subsurface utilities; foundation openings; air temperature and pressure differentials and building ventilation.

Radon may migrate into a study area by either a pressure-driven transport or no-pressure differentials. The subject buildings were likely built slab-on-grade. Radon may migrate through foundations by the availability of expansion joints and cracks in the foundation. Radon may also migrate into a building through basements, utility trenches, pipe runs, HVAC systems, and other building ventilation systems. Radon contributions from building materials off-gassing are not often the source of measurable radon.

#### **6.0 RADON TESTING ACTIVITY**

The EPA has shown that radon concentration levels may vary from room to room in schools in the same building. It is also known that radon measurements for a particular room are not always precise indicators of radon measurements in adjacent rooms. ORS 332.166-167 has therefore required that radon measurement teams measure radon in schools with initial radon measurements conducted in all frequently occupied rooms in contact with the soil or above a basement crawlspace.

The OHA requires a simultaneous initial test of all frequently occupied rooms including such rooms as offices, classrooms, a media entry area, a commons area, conference rooms, gymnasiums, auditoriums, common rooms/cafeteria, and break room. The OHA requires a minimum of one detector per every 2,000 square feet of open floor space or a portion of the room as required. The EPA has also noted that radon levels on upper floors are not likely to exceed the levels of lower rooms. The EPA has determined that testing the ground-level floors is sufficient for initial radon concentration determinations.

EPA recommends that initial measurements be performed by the utilization of short-term testers placed in the lowest section of the subject buildings and performed under closed-door conditions. An initial short-term test ensures that school students and workers may be informed quickly if radon measurements reveal elevated radon test levels. If the short-term measurement is greater than 4 picoCuries per liter (pCi/L) or 0.02 working levels (WL), a follow-up measurement is recommended. The purpose of the follow-up measurement is to determine whether radon mitigation is necessary for the measurement area.

### **7.0 RADON TEST RESULTS TABLE SUMMARY**

The retest episode for Eddyville Charter School was conducted between Friday, April 21st, 2023, and Monday, April 24th, 2023. The eight (8) radon samplers were sent to PRO-LAB on Monday, April 24th, 2023, and the results were reported to EIS on Friday, April 28th, 2023. The radon sampling episode was conducted by Matthew C. Spear, field representative of Environmental Inspection Services Pro LLC (EIS) with an escort through the facilities listed above. Of these eight (8) samples, none were above the 4pCi/L action limit, based on the short-term radon results reported by PRO-LAB. The findings of the short-term (48-96 hour) radon retest sampling test episode conducted at the Eddyville Charter School can be found in Appendix 1.0 and in the table below.

<b>Sample Number</b>	<b>Serial Number</b>	<b>Location</b>	<b>Results</b>
001	5272087	Music Room	0.5 pCi/L
002	5272076	Music Room (Dup)	0.4 pCi/L
003	5271549	Room 55	0.3 pCi/L
004	5271579	Room 55 (Dup)	0.5 pCi/L
005	5271497	Room 54	0.4 pCi/L
006	5271607	Room 54 (Dup)	0.4 pCi/L
007	5271682	Room 49	0.3 pCi/L
008	5271793	Room 49 (Dup)	< 0.3 pCi/L

### **8.0 RADON MEASUREMENT RISK ASSESSMENT**

No additional long-term test radon testing and mitigation are recommended for the Eddyville Charter School building at this time based on the radon short-term analytical test results.

The U.S. surgeon general has warned about the health risk from exposure to radon in indoor air. The surgeon general has urged Americans to test their homes because radon is the leading cause of lung cancer for non-smokers in the United States and breathing in radon over prolonged periods can present a significant health risk. The USEPA has estimated that approximately 21,000 lung cancer-related deaths occur annually with an estimated 275 lung cancer deaths annually in Oregon.

### **9.0 RADON LABORATORY ANALYSIS**

The radon in test samplers was measured at the Pro-Lab Laboratory located at 1675 North Commerce Parkway in Weston, Florida using the liquid scintillation Method (EPA 402-R-92-004) The selected radon sampler devices utilized at the Columbia Gorge Educational Service District buildings are described as a passive activated charcoal adsorption devices (AC).

The short-term testers utilize activated carbon to absorb the radon gas in the air. The test unit has activated carbon with a perforation screen to filter out radon decay products. The absorber is resealed by EIS and shipped to Pro-Lab for processing and evaluation. The selected passive radon tester devices do not uniformly adsorb radon during the testing episode and are not described as integrating devices.

### **10.0 QUALITY ASSURANCE & CONTROL**

Quality Assurance measurements were conducted during the initial testing episode. Minimum acceptable standards of precision and accuracy were maintained during the entire course of the radon testing period. The Quality Assurance protocol included the inclusion of side-by-side detectors (duplicates) and unexposed control detectors (Blanks).

The “blanks” are defined as tester measurements by analyzing unexposed (closed) radon detectors that accompany exposed detectors to the field. The school district may utilize blanks to assess any change in analysis caused by anything outside the immediate room conditions. Background levels may be due to leakage of radon into the tester, detector response to gamma radiation, or other causes.

The duplicates were placed as pairs of detectors deployed in the same location side by side during the identical testing periods. Duplicate placements were at least ten percent of the measurement locations. The duplicates were placed, shipped, and manifested with chains of custody to Pro-lab for analysis in the same manner as the other devices so that processing at the laboratory could not distinguish the testers.

Spike samples are handled and spiked by the PRO-LAB laboratory and results remain as internal tests and confidential per regulation. Spike samples are routinely conducted per the laboratory proficiency requirements.

An independent company, Bowser Morner located at 4514 Taylorsville Road (phone No. 937-236-8805) conducts routine controls for PRO-LAB. Bowser Morner participated in spike testing using liquid scintillation charcoal devices (NRPP device Code # 7084). None of the values of absolute individual Relative Error of the reported measurements was greater than 25%; therefore, the lab passed the performance test. The letter was signed by Rebecca J. Turek, Manager of the Radon Reference laboratory of Bowser-Morner, Inc. A copy of the results of the performance test is attached as Appendix 1.0.

### **11.0 FINDINGS, OPINIONS, & CONCLUSIONS**

In the opinion of EIS, no additional long-term radon retesting is required at the Eddyville Charter School building. The sample analytical result tables are listed in Appendix 1.0 of this report.

### **12.0 LIMITATIONS**

This report was prepared in accordance with generally accepted ASTM standards of environmental practice at the time this investigation was performed. Evaluations of the conditions at the site for the purpose of this investigation are made from a limited number of observations and sample points and may be subjective in some cases. The client is solely responsible for providing any notices or disclosures to concerned public agencies or to the public.

Environmental Inspection Services Pro LLC has prepared this report based on information collected from available analytical test results. The scope of this investigation is limited and did include a limited number of radon testers and no subsurface or sub-slab radon screening of soil and groundwater. No radon mitigation was performed on the subject property.

This report is not a substitution for a formal radon mitigation and/or radon mitigation effort. The findings and conclusions are not to be regarded as scientific certainties. Findings are based on professional judgment concerning independent laboratory data significance. This report is an expression of professional opinion and is not a warranty expressed or implied.



## **APPENDIXES**

<b>RADON ANALYTICAL TEST RESULTS. ....</b>	<b>APPENDIX 1.0</b>
<b>SAMPLE LOCATIONS.....</b>	<b>APPENDIX 2.0</b>
<b>RADON REGULATION.....</b>	<b>APPENDIX 3.0</b>

**APPENDIX 1.0**

**RADON ANALYTICAL TEST RESULTS**



# RADON ANALYSIS REPORT

1675 North Commerce Parkway, Weston, FL 33326 (954) 384-4446

TEST ID NUMBER: 1458706  
DATE RECEIVED: 04/26/2023  
REPORT DATE: 04/28/2023

ENVIRONMENTAL INSPECTION SERVICE, INC.  
11981 FARGO ROAD NORTHEAST,  
AURORA, OR 97002

**TEST LOCATION**  
EDDYVILLE CHARTER SCHOOL  
1 EDDYVILLE SCHOOL RD  
EDDYVILLE, OR 97343

This is a confidential report of the radon samples that were submitted to our laboratory for measurements of radon-222 levels. The results represent the amount of radon that was present in the air during the time of sampling. The radon is measured in our laboratory using the liquid scintillation method. This report will not be released to anyone without your permission except as required by individual state laws and guidelines.

## HERE ARE YOUR TEST RESULTS

<u>VIAL #</u>	<u>ROOM TESTED</u>	<u>DATE OPENED</u>	<u>DATE CAPPED</u>	<u>DATE ANALYZED</u>	<u>RADON LEVEL</u>
5272087	1ST FLOOR MUSIC ROOM	Apr 21, 2023 7:00 AM	Apr 24, 2023 7:15 AM	Apr 27, 2023 9:37 AM	0.5 pCi/L
5271711	1ST FLOOR MUSIC ROOM DUP	Apr 21, 2023 7:00 AM	Apr 24, 2023 7:15 AM	Apr 27, 2023 9:47 AM	0.4 pCi/L

### THE EPA RECOMMENDS THAT YOU FIX YOUR HOME IF THE RADON LEVEL IS 4 PICOCURIES (PCi/L) OR HIGHER

Please read the EPA Citizen's Guide to Radon at [www.epa.gov/radon/pubs/citguide.html](http://www.epa.gov/radon/pubs/citguide.html). Residents of New Jersey should read "Radon Testing and Mitigation: The Basics" at <http://njradon.org/download/mitbas.pdf>. Radon levels less than 4 pCi/L still pose a risk. You may want to take additional measurements because radon levels can vary with the seasons. You may also want to consider doing a long term test to determine the average radon concentrations over a longer period of time. If the radon level is 4.0 pCi/L or higher you should perform either a long-term test or a second short-term test. If the radon level is higher than 8 pCi/L you should perform a second short-term test immediately. **If you would like to learn how to lower your radon levels, or have other questions, please contact your state radon office.**

### LIMITATIONS OF DATA AND PRODUCT LIABILITY

PRO-LAB expressly disclaims any and all liability for any special, incidental, or consequential damages resulting directly or indirectly from the improper use of or improper interpretation of the radon product or its results. Any delays in receipt of the test sample by PRO-LAB shall be the sole responsibility of the purchaser and their legal remedy shall be limited to recourse with their chosen carrier. Additionally, PRO-LAB shall not be responsible for the improper placement of the test canister nor shall PRO-LAB be liable for results derived directly or indirectly from the improper placement of said test canister. PRO-LAB, its agents, its retailers, its distributors, and the manufacturers' sole liability are limited to the cost for the replacement of the test canister itself only.

Jose Figueroa, RMS  
NRPP CERT # 109347 RT  
NRSB CERT # 18SS007

PRO-LAB NRSB # ARL0028  
PRO-LAB NEHA ID # 101461AL

James E. McDonnell IV



# RADON ANALYSIS REPORT

1675 North Commerce Parkway, Weston, FL 33326 (954) 384-4446

TEST ID NUMBER: 1458708  
DATE RECEIVED: 04/26/2023  
REPORT DATE: 04/28/2023

ENVIRONMENTAL INSPECTION SERVICE, INC.  
11981 FARGO ROAD NORTHEAST,  
AURORA, OR 97002

**TEST LOCATION**  
EDDYVILLE CHARTER SCHOOL  
1 EDDYVILLE SCHOOL RD  
EDDYVILLE, OR 97343

This is a confidential report of the radon samples that were submitted to our laboratory for measurements of radon-222 levels. The results represent the amount of radon that was present in the air during the time of sampling. The radon is measured in our laboratory using the liquid scintillation method. This report will not be released to anyone without your permission except as required by individual state laws and guidelines.

## HERE ARE YOUR TEST RESULTS

<u>VIAL #</u>	<u>ROOM TESTED</u>	<u>DATE OPENED</u>	<u>DATE CAPPED</u>	<u>DATE ANALYZED</u>	<u>RADON LEVEL</u>
5271541	1ST FLOOR 55	Apr 21, 2023 7:00 AM	Apr 24, 2023 7:15 AM	Apr 27, 2023 6:03 AM	0.3 pCi/L
5271354	1ST FLOOR 55 DUP	Apr 21, 2023 7:00 AM	Apr 24, 2023 7:15 AM	Apr 27, 2023 6:14 AM	0.5 pCi/L

### THE EPA RECOMMENDS THAT YOU FIX YOUR HOME IF THE RADON LEVEL IS 4 PICOCURIES (PCi/L) OR HIGHER

Please read the EPA Citizen's Guide to Radon at [www.epa.gov/radon/pubs/citguide.html](http://www.epa.gov/radon/pubs/citguide.html). Residents of New Jersey should read "Radon Testing and Mitigation: The Basics" at <http://njradon.org/download/mitbas.pdf>. Radon levels less than 4 pCi/L still pose a risk. You may want to take additional measurements because radon levels can vary with the seasons. You may also want to consider doing a long term test to determine the average radon concentrations over a longer period of time. If the radon level is 4.0 pCi/L or higher you should perform either a long-term test or a second short-term test. If the radon level is higher than 8 pCi/L you should perform a second short-term test immediately. **If you would like to learn how to lower your radon levels, or have other questions, please contact your state radon office.**

### LIMITATIONS OF DATA AND PRODUCT LIABILITY

PRO-LAB expressly disclaims any and all liability for any special, incidental, or consequential damages resulting directly or indirectly from the improper use of or improper interpretation of the radon product or its results. Any delays in receipt of the test sample by PRO-LAB shall be the sole responsibility of the purchaser and their legal remedy shall be limited to recourse with their chosen carrier. Additionally, PRO-LAB shall not be responsible for the improper placement of the test canister nor shall PRO-LAB be liable for results derived directly or indirectly from the improper placement of said test canister. PRO-LAB, its agents, its retailers, its distributors, and the manufacturers' sole liability are limited to the cost for the replacement of the test canister itself only.

Jose Figueroa, RMS  
NRPP CERT # 109347 RT  
NRSB CERT # 18SS007

PRO-LAB NRSB # ARL0028  
PRO-LAB NEHA ID # 101461AL

James E. McDonnell IV



# RADON ANALYSIS REPORT

1675 North Commerce Parkway, Weston, FL 33326 (954) 384-4446

TEST ID NUMBER: 1458710  
DATE RECEIVED: 04/26/2023  
REPORT DATE: 04/28/2023

ENVIRONMENTAL INSPECTION SERVICE, INC.  
11981 FARGO ROAD NORTHEAST,  
AURORA, OR 97002

**TEST LOCATION**  
EDDYVILLE CHARTER SCHOOL  
1 EDDYVILLE SCHOOL RD  
EDDYVILLE, OR 97343

This is a confidential report of the radon samples that were submitted to our laboratory for measurements of radon-222 levels. The results represent the amount of radon that was present in the air during the time of sampling. The radon is measured in our laboratory using the liquid scintillation method. This report will not be released to anyone without your permission except as required by individual state laws and guidelines.

## HERE ARE YOUR TEST RESULTS

<u>VIAL #</u>	<u>ROOM TESTED</u>	<u>DATE OPENED</u>	<u>DATE CAPPED</u>	<u>DATE ANALYZED</u>	<u>RADON LEVEL</u>
5271596	1ST FLOOR 54	Apr 21, 2023 7:00 AM	Apr 24, 2023 7:15 AM	Apr 27, 2023 7:29 AM	0.4 pCi/L
5271446	1ST FLOOR 54 DUP	Apr 21, 2023 7:00 AM	Apr 24, 2023 7:15 AM	Apr 27, 2023 7:40 AM	0.4 pCi/L

### THE EPA RECOMMENDS THAT YOU FIX YOUR HOME IF THE RADON LEVEL IS 4 PICOCURIES (PCi/L) OR HIGHER

Please read the EPA Citizen's Guide to Radon at [www.epa.gov/radon/pubs/citguide.html](http://www.epa.gov/radon/pubs/citguide.html). Residents of New Jersey should read "Radon Testing and Mitigation: The Basics" at <http://njradon.org/download/mitbas.pdf>. Radon levels less than 4 pCi/L still pose a risk. You may want to take additional measurements because radon levels can vary with the seasons. You may also want to consider doing a long term test to determine the average radon concentrations over a longer period of time. If the radon level is 4.0 pCi/L or higher you should perform either a long-term test or a second short-term test. If the radon level is higher than 8 pCi/L you should perform a second short-term test immediately. **If you would like to learn how to lower your radon levels, or have other questions, please contact your state radon office.**

### LIMITATIONS OF DATA AND PRODUCT LIABILITY

PRO-LAB expressly disclaims any and all liability for any special, incidental, or consequential damages resulting directly or indirectly from the improper use of or improper interpretation of the radon product or its results. Any delays in receipt of the test sample by PRO-LAB shall be the sole responsibility of the purchaser and their legal remedy shall be limited to recourse with their chosen carrier. Additionally, PRO-LAB shall not be responsible for the improper placement of the test canister nor shall PRO-LAB be liable for results derived directly or indirectly from the improper placement of said test canister. PRO-LAB, its agents, its retailers, its distributors, and the manufacturers' sole liability are limited to the cost for the replacement of the test canister itself only.

Jose Figueroa, RMS  
NRPP CERT # 109347 RT  
NRSB CERT # 18SS007

PRO-LAB NRSB # ARL0028  
PRO-LAB NEHA ID # 101461AL

James E. McDonnell IV



# RADON ANALYSIS REPORT

1675 North Commerce Parkway, Weston, FL 33326 (954) 384-4446

TEST ID NUMBER: 1458711  
DATE RECEIVED: 04/26/2023  
REPORT DATE: 04/28/2023

ENVIRONMENTAL INSPECTION SERVICE, INC.  
11981 FARGO ROAD NORTHEAST,  
AURORA, OR 97002

**TEST LOCATION**  
EDDYVILLE CHARTER SCHOOL  
1 EDDYVILLE SCHOOL RD  
EDDYVILLE, OR 97343

This is a confidential report of the radon samples that were submitted to our laboratory for measurements of radon-222 levels. The results represent the amount of radon that was present in the air during the time of sampling. The radon is measured in our laboratory using the liquid scintillation method. This report will not be released to anyone without your permission except as required by individual state laws and guidelines.

## HERE ARE YOUR TEST RESULTS

<u>VIAL #</u>	<u>ROOM TESTED</u>	<u>DATE OPENED</u>	<u>DATE CAPPED</u>	<u>DATE ANALYZED</u>	<u>RADON LEVEL</u>
5271869	1ST FLOOR 49	Apr 21, 2023 7:00 AM	Apr 24, 2023 7:15 AM	Apr 27, 2023 7:51 AM	0.3 pCi/L
5271555	1ST FLOOR 49 DUP	Apr 21, 2023 7:00 AM	Apr 24, 2023 7:15 AM	Apr 27, 2023 8:02 AM	< 0.3 pCi/L **

**\*\* One or more analysis results fall under the Lower Limit of Detection of 0.3 pCi/L.**

### THE EPA RECOMMENDS THAT YOU FIX YOUR HOME IF THE RADON LEVEL IS 4 PICOCURIES (PCi/L) OR HIGHER

Please read the EPA Citizen's Guide to Radon at [www.epa.gov/radon/pubs/citguide.html](http://www.epa.gov/radon/pubs/citguide.html). Residents of New Jersey should read "Radon Testing and Mitigation: The Basics" at <http://njradon.org/download/mitbas.pdf>. Radon levels less than 4 pCi/L still pose a risk. You may want to take additional measurements because radon levels can vary with the seasons. You may also want to consider doing a long term test to determine the average radon concentrations over a longer period of time. If the radon level is 4.0 pCi/L or higher you should perform either a long-term test or a second short-term test. If the radon level is higher than 8 pCi/L you should perform a second short-term test immediately. **If you would like to learn how to lower your radon levels, or have other questions, please contact your state radon office.**

### LIMITATIONS OF DATA AND PRODUCT LIABILITY

PRO-LAB expressly disclaims any and all liability for any special, incidental, or consequential damages resulting directly or indirectly from the improper use of or improper interpretation of the radon product or its results. Any delays in receipt of the test sample by PRO-LAB shall be the sole responsibility of the purchaser and their legal remedy shall be limited to recourse with their chosen carrier. Additionally, PRO-LAB shall not be responsible for the improper placement of the test canister nor shall PRO-LAB be liable for results derived directly or indirectly from the improper placement of said test canister. PRO-LAB, its agents, its retailers, its distributors, and the manufacturers' sole liability are limited to the cost for the replacement of the test canister itself only.

Jose Figueroa, RMS  
NRPP CERT # 109347 RT  
NRSB CERT # 18SS007

PRO-LAB NRSB # ARL0028  
PRO-LAB NEHA ID # 101461AL

James E. McDonnell IV

## **APPENDIX 2.0**

### **SAMPLE LOCATIONS**

PLAYSHED

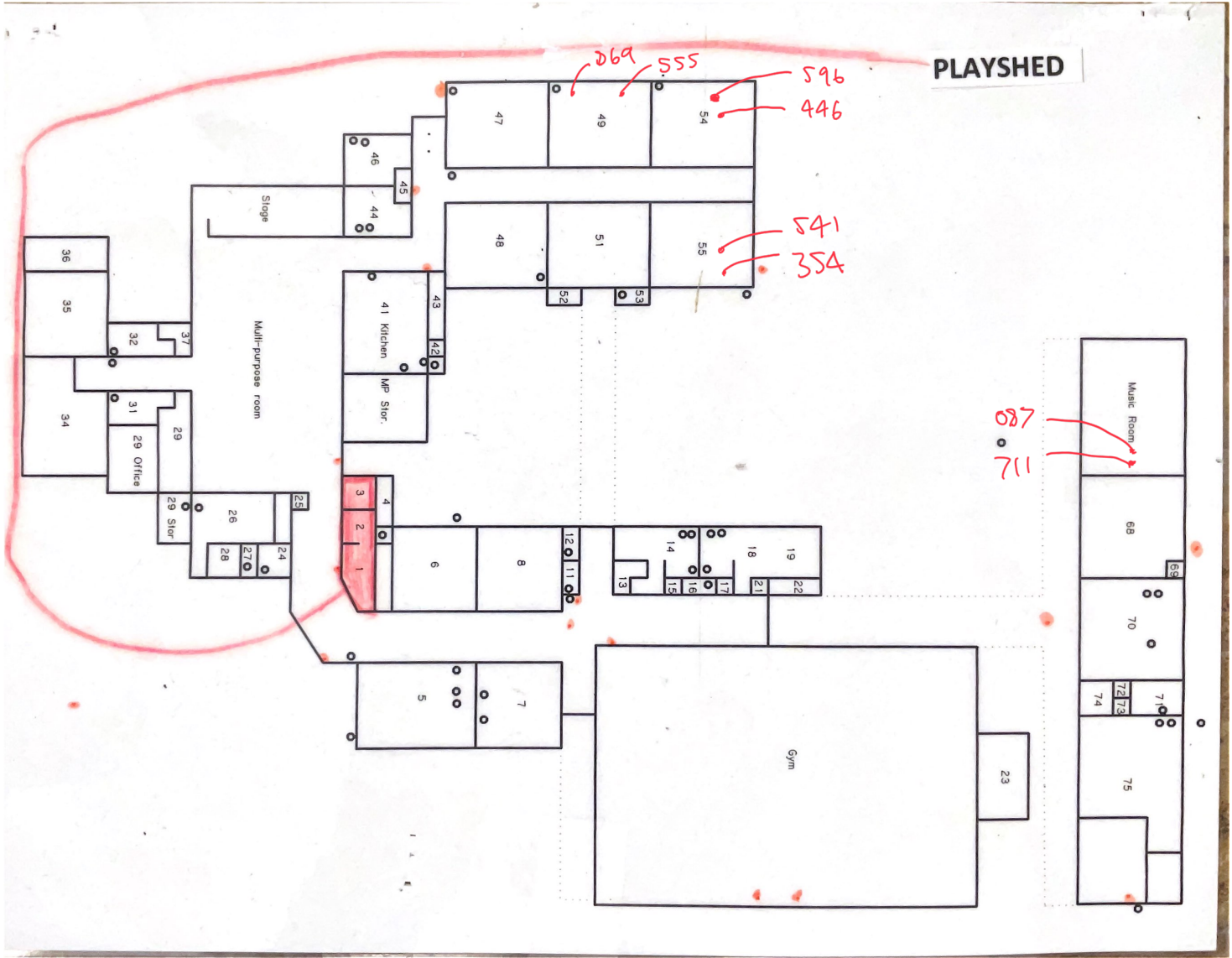

087  
711

269  
555  
596  
446  
541  
354

Music Room  
68  
70  
71  
72  
73  
74  
75

Multi-purpose room

Stage

41 Kitchen

MP Stor.

29 Office

Gym



## **APPENDIX 3.0**

### **RADON REGULATION**

# Testing for Elevated Radon in Oregon Schools



Version 1.0 - 2016

A Protocol and Plan

This document provides Oregon school districts with a protocol to accurately test for elevated radon levels in school buildings, per Oregon Revised Statute (ORS) 332.166-167.

Plans may be submitted by e-mail, fax, or mail to:

*Oregon Radon Awareness Program*

800 NE Oregon St, Suite 640

Portland, OR 97232-2162

radon.program@state.or.us

Fax: 971-673-0979

# Table of contents

» Table of contents .....	iii
» Notice .....	iv
» Acknowledgment .....	v
» Introduction .....	6
» Protocol objectives .....	7
» What is radon? .....	8
» Why is radon a problem? .....	9
» How is radon reported?.....	11
» What radon studies have been completed in schools?.....	12
» What is the U.S. EPA action level? .....	12
» Where do we spend our time? .....	12
» What are the routes of radon entry?.....	13
» Environmental factors influencing radon concentrations .....	16
» Types of radon measurement devices .....	18
» Quality assurance .....	29
» Radon testing process guide .....	33
» Interpreting initial results .....	37
» After receiving results of follow-up testing .....	39
» References.....	41
» Websites .....	42
» Glossary.....	43
» Appendix A: Radon test placement protocol checklist.....	45
» Appendix B: Signage for school radon measurement .....	48
» Appendix C: Memo to parents and staff about radon measurement .....	49
» Appendix D: Step-by-step guide for planning radon testing in Oregon schools .....	50
» Appendix E: Frequently asked questions about radon and schools.....	58

# Notice

The Oregon Health Authority prepared this protocol, which was funded by a grant from the United States Environmental Protection Agency (EPA) Region 10 Radon Program. Neither the Oregon Health Authority, United States Environmental Protection Agency, any affiliated organization nor any of their employees makes any express or implied warranty or assumes any legal liability or responsibility for the accuracy, completeness or usefulness of any information, apparatus, product or process disclosed. None of these entities or individuals represent that the protocol's use would not infringe on privately owned rights. Reference herein to any specific commercial product, process or service by trade name, trademark manufacturer, or otherwise does not necessarily constitute or imply its endorsement, recommendation or favoring by the Oregon Health Authority, United States Environmental Protection Agency or any affiliated organization.

# Acknowledgment

The Oregon Health Authority produced this protocol under direction of (ORS) 332.166-167 in partnership with the Oregon Department of Education. The protocol uses material that the American Lung Association of the Upper Midwest created under contract. The protocol was adapted with permission from the Iowa Department of Public Health. The content of this protocol was reviewed by the Oregon School Boards Association and the Oregon Radon Coalition.

Please send any comments about this document to the Oregon Health Authority Public Health Division, 800 N.E. Oregon Street, Suite 640, Portland, OR 97232. Phone: 971-673-0440.

Email [radon.program@state.or.us](mailto:radon.program@state.or.us).

[www.healthoregon.org/radon](http://www.healthoregon.org/radon).

# Introduction

Radon is the number-one cause of lung cancer among non-smokers, according to EPA estimates. Although no amount of radon is safe, people can take steps to reduce its potential for harm.

Measuring and reducing elevated radon at home is the most effective way to decrease radon's harm. School buildings are the second leading source of radon exposure for students and school employees.

Elevated radon is found throughout Oregon and in a variety of structures. The only way to know if a building has elevated radon is to test.

The 2015 Oregon Legislature passed House Bill (HB) 2931 to assess elevated radon levels in Oregon schools. HB 2931 later became Oregon Revised Statute (ORS) 332.166-167. The Oregon Health Authority (OHA), directed by ORS 332.166-167, produced this guide to help Oregon school districts accurately measure their school buildings for elevated radon. Per the statute, this guide follows current national guidelines for measuring radon in schools and large buildings (1). It is based on radon school measurement plans from other states.

Under the statute, school districts are to submit a plan to Oregon Health Authority by Sept. 1, 2016. OHA recommends, but does not require, that school districts create a specific plan for testing each school site before testing begins.

Per ORS 332.166-167, actual testing of schools must be done on or before Jan. 1, 2021. The testing results must be sent to OHA and posted on the school or school district's website. These requirements do not apply to schools that have been tested for elevated radon on or after Jan. 1, 2006.

This protocol's appendices contain "Frequently Asked Questions about Radon and Schools" and other tools and step-by-step instructions to help schools plan and carry out radon testing.

Thank you for the part you play in raising radon awareness.

Oregon Health Authority  
Public Health Division  
Radon Awareness Program

# Protocol objectives

This protocol addresses learning objectives for radon screening measurements in schools. The objectives are for schools to:

1. Accurately carry out testing schools for elevated levels of radon, per ORS 332.166-167.
2. Define the elements and components of radon and radon measurement. Schools are to use appropriate labels, terms and wording, as well as effectively communicate such definitions to others.
3. Understand the relevant laws and elements of physical science to the radon measurement process and the role of physical science in both the introduction and presence of radon in the environment.
4. Forecast how when, where and why radon occurs, and predict how radon will behave at different times, in different places and/or under different circumstances.
5. Measure relevant properties of radon; use appropriate scales of measurement; interpret both status and change; and interpret measurements' validity and reliability.
6. Use the standard devices and/or instrumentation approved for radon measurement, understand device calibration and servicing; and understand potential errors related to the devices' misuse or misplacement.
7. Model the required elements of quality control and quality assurance throughout the measurement process as a continuous part of the measurement protocol. Understand the inherent values of a quality controlled approach to measurement.
8. Comply with existing laws, regulations and other established procedural requirements associated with radon measurement. Emulate the importance of legal oversight of radon-related activities.
9. Understand the processes associated with basic radon mitigation.



## What is radon?

Radon comes from natural deposits of uranium in the soil. It is found everywhere in the world. Uranium naturally decays into radium that further breaks down into radon gas. While some geographic areas have more radon than others, the only way to determine a building's radon level is to test it. Any building has the potential for elevated levels of radon. Because radon is a gas, it can move up through the soil, allowing it to enter buildings in contact with the soil. Radon is typically at its highest concentration in the lower portion of a building. Once radon enters a building, it is easily dispersed through the air. It then begins a radioactive decay process that leads to creating radon decay products. Radon gas itself is relatively harmless until it produces these decay products. The decay products release damaging energy particles that strike lung tissue and lead to lung tissue damage if inhaled.

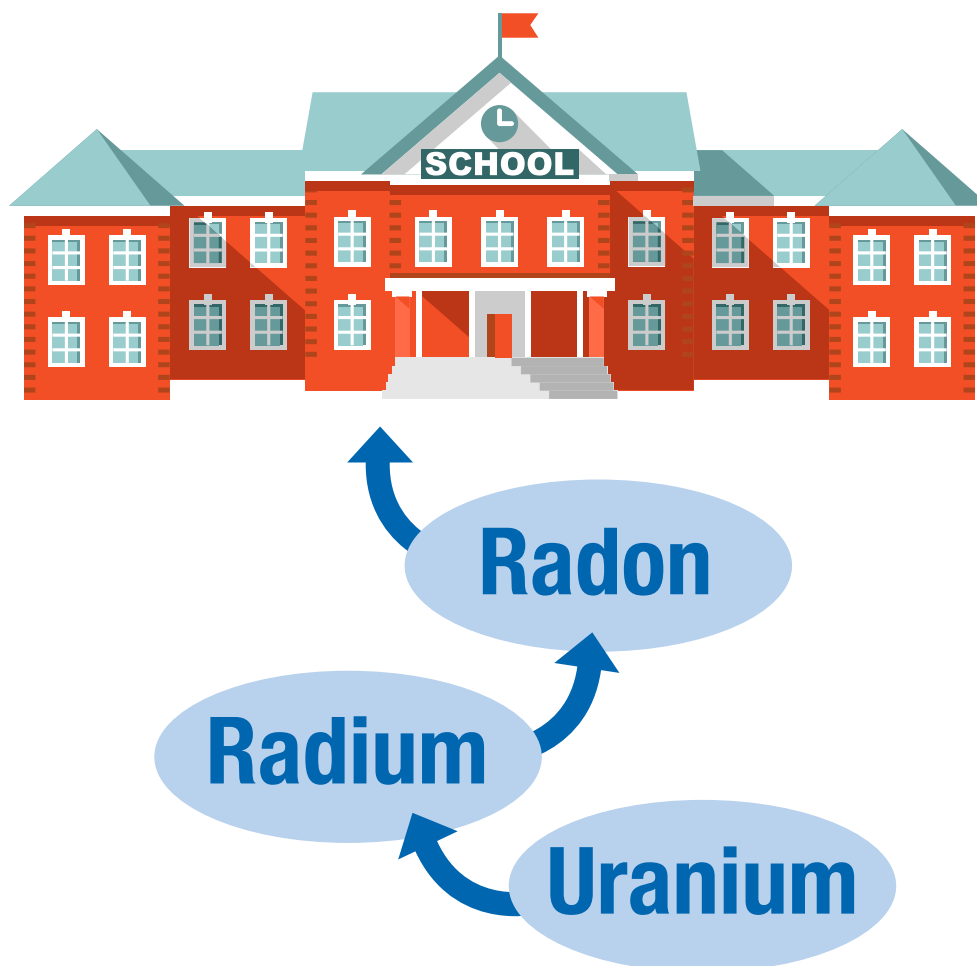

## Why is radon a problem?

Radon is a naturally occurring colorless, odorless, tasteless and radioactive gas. Radon travels through the soil and enters buildings through cracks and openings in the foundation. This can occur in buildings or homes of any age and structural type (e.g., with or without basements). Eventually, radon decays into radioactive particles (decay products) that can be trapped in the lungs when you breathe. As these particles decay further, they release small bursts of radiation. This radiation can damage lung tissue and lead to lung cancer over the course of a lifetime.

Radon is a human carcinogen. Prolonged exposure to elevated radon concentrations causes an increased risk of lung cancer. Like other environmental pollutants, the extent of radon's health risk is uncertain. However, scientists are more certain about risks from radon than from other cancer-causing environmental pollutants, such as the herbicide glyphosate or the flame retardant chemicals polybrominated biphenyls (PBBs). This is because estimates of radon risk are based on studies of cancer in humans (underground miners and other more current epidemiological studies).

The Surgeon General has warned Americans about the health risk from exposure to radon in indoor air (2) and urged Americans to perform radon testing. Radon is the leading cause of lung cancer for non-smokers in the United States. Breathing radon over prolonged periods can present a significant health risk (3). Other health agencies, including the U.S. Centers for Disease Control and Prevention and the World Health Organization, have made similar conclusions about radon's danger to human health.

### Radon and lung cancer

The U.S. Environmental Protection Agency (EPA) ranks radon in the highest classification of cancer-causing substances – Group A. This category only includes those substances with sufficient evidence of causing cancer in humans.

#### **EPA's classification of cancer-causing agents:**

- Group A: Known human carcinogen (e.g., radon)
- Group B: Probable carcinogenic (e.g., glyphosate; polybrominated biphenyls)
- Group C: Possibly carcinogenic
- Group D: Not classifiable (no data) and
- Group E: Evidence of non-carcinogenicity

## How does radon cause cancer?

Unlike radon, which is a gas, radon decay products are solid particles. These particles become suspended in the air when they are formed. Some of these particles “plate out” (attach to surfaces) and attach themselves to aerosols, dust and smoke particles in the air. Inhaling these particles can deliver a radiation dose to the lungs that can damage lung tissue and affect DNA.

DNA is the fundamental blueprint for all of the body’s structures: The DNA blueprint is encoded in each single human cell. Each cell is continually reading various parts of its own DNA as it constructs fresh molecules to perform a variety of tasks.

The small decay particles, called progeny, exert energy (called ionizing radiation) on the lung tissue and cause damage. They can even strike and disrupt the cell DNA, which damages the cancer suppressant gene and increases the risk for contracting cancer. These collisions and ionization take place very quickly, but the biological effects (i.e., beginnings of cancer) take much longer to emerge. Cancer is produced when the altered DNA code leaves an error in the DNA blueprint. The risk of lung cancer is based on how much you are exposed to and for how long. Scientific research indicates that at least a 10- to 20-year incubation period is required before lung cancer develops.

The EPA estimates that 21,000 radon-related lung cancer deaths occur each year in the United States. Below is a table of estimated U.S. deaths from different cancer types in 2015. If radon-induced lung cancer were its own category (see table on [page 11](#)), it would be our country’s eighth leading cause of death from cancer.

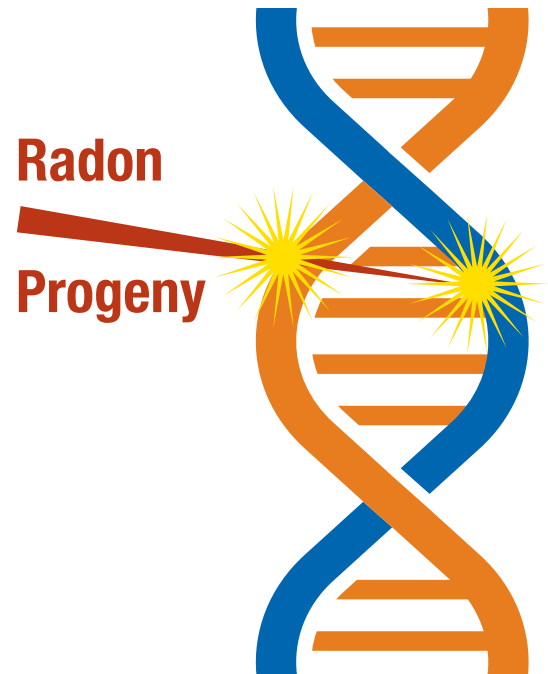

*Radon in air continues to decay. These decay products are known as radon progeny and disrupt cell DNA.*

## Cancer types and estimated U.S. deaths, 2015 (4,5)

Cancer type	Estimated U.S. deaths in 2015
1. Lung and bronchus	158,040
2. Colon and rectum	49,700
3. Breast cancer	40,730
4. Pancreas	40,560
5. Prostate	27,540
6. Liver and bile duct	24,550
7. Leukemia	24,450
<b>Radon-induced lung cancer</b>	<b>21,000</b>
8. Lymphoma	20,940
9. Urinary bladder	16,000
10. Esophagus	15,500
11. Ovary	14,180

Another report of annual deaths from radon-induced lung cancer comes from the National Research Council. It estimates that one in 10 or one in seven (depending on the risk model) of all lung-cancer deaths — ranging from 15,400 or 21,800 per year in the United States — can be attributed to radon exposure. This range is made up of adding deaths from radon exposure among people who have smoked at least 100 cigarettes in their lives (ever-smokers) together with deaths attributable to radon among never-smokers. (6)

Not everyone who breathes in radon (or radon decay products) will develop lung cancer. An individual's risk of lung cancer depends mostly on the concentration of radon, the duration of exposure (over a lifetime) and genetic and health disposition. Smoking combined with radon is an especially serious health risk. The risk of dying from lung cancer caused by radon is much greater for smokers than non-smokers.

Breathing radon does not cause any short-term human health symptoms such as shortness of breath, coughing, headaches or fever. Children (who have higher respiration rates than adults) have been reported to have greater risk than adults for certain types of cancer from radiation. However, no conclusive data exists at this time on whether children are at greater risk than adults from radon. There is no conclusive data at this time that radon exposure causes illnesses other than lung cancer.

## How is radon reported?

In the United States, radioactive materials are measured in curies. A curie is the amount of radioactivity released from one gram of radium. A picocurie is

a millionth of a millionth, or a trillionth, of a curie. Radon is measured and reported in picocuries per liters of air (pCi/L).

## What radon studies have been completed in schools?

The EPA began investigating radon in schools in 1988. The initial studies show that there were elevated levels of radon in schools in every state.

A further study called the National School Radon Survey showed that 19.3% of all U.S. schools (nearly one in five) have at least one frequently occupied room with short-term radon levels above the **U.S. EPA action level: ( $\geq 4.0$  pCi/L)**. In total, EPA estimates that radon has affected more than 70,000 schoolrooms. (7)

## What is the U.S. EPA action level?

U.S. EPA recommends reducing the concentration of radon in indoor environments to below the radon action level of 4.0 pCi/L. This action is not health-based; there is no safe level of radon exposure. While the radon in most buildings can be lowered below 4.0 pCi/L, this may depend on the building's and its grounds' characteristics.

Yet because outdoor levels of radon across the country average 0.4 pCi/L, it's not possible to reduce people's risk from radon exposure to zero. Although no amount of radon is good for a person, radon reduction's goal is to reduce the level and, thus, reduce potential harm.

## Where do we spend our time?

A study for the U.S. EPA shows that we spend 87.9% of our time indoors on a daily basis (8). Because many people, particularly children, spend much of their time at home, the home is likely the most significant source of radon exposure. The U.S. EPA estimates that one in 15 U.S. homes have elevated radon 4pCi/L. (9) Some areas of Oregon are found to have higher radon levels than others. But it is very possible that a home in an area considered to have low risk could have elevated radon levels. The opposite could also be true.

---

***The only way to know whether a home has elevated radon levels is to test it.***

---

The second largest contributor to radon exposure for most school children and staff is likely to be their school. As a result, both the EPA and the Oregon Health Authority (OHA) recommend that school buildings as well as homes be tested for radon. This recommendation became law for Oregon schools in the 2015 Legislature (ORS 332.166-167).

# What are the routes of radon entry?

Many factors contribute to the entry of radon gas into a school building. Schools that are in the same community can have significantly different radon levels from one another. As a result, school officials cannot know if elevated levels of radon are present without testing.

## Radon levels in buildings

### The level of radon in a building depends on:

- The concentration of uranium and radium in the soil or underlying geology;
- How easily the radon can be transported into the building through the soil permeability, pathways and openings into the building;
- Air differentials, e.g., the stack effect where warm indoor air leaving the upper parts of a structure is naturally replaced by colder air that may contain radon gas (if at high concentrations in soil);
- How air is transported within a building;
- The ventilation rate of the building.

## Entry through pressure-driven transport

The most common way for radon to enter a building is from the soil gas through pressure-driven transport. Pressure-driven transport occurs when a lower indoor air pressure draws air from the soil or bedrock into the building.

### Radon transport through soil to building requires:

- A driving force – a force that draws or pushes the radon toward the building;
- A pathway to the home or building – high soil permeability, utility trenches, etc.;
- Openings in the foundation – joints, cracks, earthen areas, utility penetrations, etc.

Schools and large buildings usually operate with an inside air pressure that is lower than the surrounding soil. This allows air, including radon (if present) outside or underneath the building, to be sucked inside. The design and operation of mechanical ventilation systems may also depressurize the building and enhance radon entry.



*The air pressure in your home is lower than pressure in the soil under your home's foundation. This difference in pressure makes your house act like a vacuum that sucks radon in through foundation cracks and other openings.*

- Buildings can create vacuums that will draw in soil gas.
- These vacuums are very small and are referred to as air pressure differentials.

## Entry through diffusion

Radon also can enter buildings when there are no pressure differences. This type of radon movement is called diffusion-driven transport. Diffusion is the same mechanism that causes a drop of food coloring placed in a glass of water to spread through the entire glass. Diffusion-driven transport is rarely the cause of elevated radon levels in existing buildings. It is also highly unlikely that diffusion contributes significantly to elevated radon levels in schools and other large buildings. Many schools and large buildings are built on adjoining slab-on-grade construction, which allows radon gas to enter through the foundation and expansion joints between the slabs as well as cracks in the slabs themselves.

## Entry through other mechanisms

Other features, such as the presence of a basement area, crawl spaces, utility tunnels, sub slab heating, ventilation and air conditioning (HVAC) ducts, sumps, drains, cracks, or other penetrations in the slab (e.g., around pipes) also provide areas for radon to enter indoor spaces.

### Man-made pathways

- The construction process can disturb native fills and make them more permeable.
- Utility lines and water collection systems often lay in trenches with loose fill or gravel.

### Slab penetrations

- Plumbing block-outs for tubs, commodes, showers etc.
- Most are hidden during construction.
- Radon follows loose fill in plumbing trench and is drawn through slab openings.

### Plumbing block-outs

- Radon follows plumbing through block-out.

## Entry through well water

Another way radon can enter a building is through well (or spring) water. In certain areas of the country, well water supplied directly to a building and in contact with radium-bearing formations can be a source of radon in a building due to the off-gassing of radon when the water is brought inside. Extremely high levels of radon in well water will raise radon gas levels in buildings. For example, 10,000 pCi/L of radon in well water is expected to increase, by itself, the radon in a structure by 1.0 pCi/L. The majority of elevated radon in most buildings will come from the soil underneath, not the well water. To date, the only known health risk associated with exposure to radon in water is a result of the airborne radon released from the water when it is used. For more information on well water quality, contact the Oregon Domestic Well Safety Program at [www.healthoregon.org/wells](http://www.healthoregon.org/wells).

## Entry through building materials

Radon can also come from building materials. However, this is rarely the cause of elevated levels in existing schools and other large buildings. Building materials — such as concrete, brick stones for fireplaces, granite and sheet rock — may contain some radium and can be sources of indoor radon. The extent of the use of radium-contaminated building materials is unknown, but it is generally believed to be very minor.

## Entry through HVAC systems

Depending on their design and operation, HVAC systems can influence radon levels in schools by increasing ventilation (diluting indoor radon concentrations with outdoor air); decreasing ventilation (allowing radon gas to build up); pressurizing a building (keeping radon out); or depressurizing a building (drawing radon inside). HVAC systems can transport radon from an area of high concentration to one of low concentration.

Schools may have overall indoor air quality concerns. Many schools have poor indoor air quality due in part from low rates of ventilation (low outdoor air intake). Poor air exchange can also increase concentration of common asthma triggers like mold and dust mites. The frequency and thoroughness of HVAC maintenance can also play an important role. For example, if air intake filters are not periodically cleaned and changed, this can significantly reduce the amount of outdoor air ventilating the indoor environment. Less ventilation allows radon to build up indoors. An understanding of the design, operation and maintenance of a school's HVAC system and how it influences indoor air conditions is essential for understanding and managing a radon problem. [This is also true for other indoor air quality concerns in schools.]



# Environmental factors influencing radon concentrations

Seasonal and mechanical variations can affect radon concentrations. Radon levels vary constantly – daily and seasonally. In the summer, with windows and doors open and warmer temperatures, we would expect lower concentrations. During the warm months when buildings are either open or well ventilated through air conditioning, the indoor radon levels are largely determined by geologic rather than mechanical factors. Finally, room users can cause radon levels to increase by inadvertently blocking air returns, etc.

## Radon varies constantly

Lowest level



SUMMER

Highest level



WINTER

## Environmental effects: frost or other factors that “cap” soil

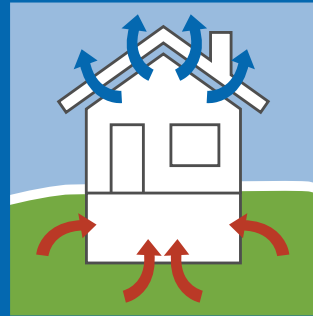

- Frost can “cap” the soil so negative pressure of buildings is exerted on larger area.
- Asphalt aprons around large buildings can have the same effect.

## Rain effects

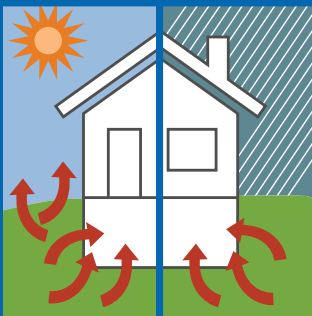

- Can “cap” the soil.
- Can displace and force soil gas into building.
- Often accompanied with barometric pressure changes.

## Effects of open windows

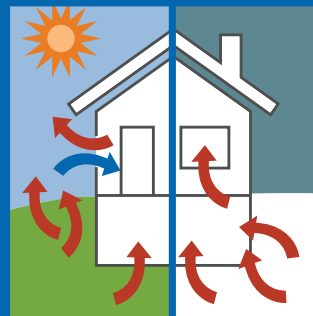

- Reduces vacuum and thereby reduces radon entry into building.
- Increases natural ventilation and radon dilution.
- Open windows do not reflect radon potential.

## What rooms should be tested?

EPA's research has shown that radon levels in schools often vary greatly from room to room in the same building. A known radon measurement result for a given classroom cannot be used as an indicator of the radon level in adjacent rooms.

Therefore, per ORS 332.166-167, school radon measurement teams (i.e., personnel appointed to measure a school site for elevated radon) must, at a minimum, conduct initial measurements in all frequently occupied rooms in contact with the soil or located above a basement or a crawlspace.

### School testing

- All frequently occupied rooms should be tested at the same time.
- Room examples include offices, classrooms, conference rooms, gyms, auditoriums, cafeterias and break rooms.
- A minimum of one detector for every 2,000 square feet of open floor space or portion thereof is required.

The EPA studies indicate that radon levels on upper floors are not likely to exceed the levels found in ground-contact rooms. Testing rooms on the ground-contact floor or above unoccupied basements or crawlspaces is sufficient to determine if radon is a problem in a school. Areas such as restrooms, hallways, stairwells, elevator shafts, utility closets and kitchens storage closets do not need to be tested (Note: These areas may be important areas for diagnostic testing if elevated radon is found.)

# Types of radon measurement devices

There are two main categories of radon test kits:

1. Passive – do not require external power to make them work.
2. Active (continuous) – require power to function (from batteries, DC adaptors or electricity from the wall)

A passive device is recommended for school district testing. Passive devices require no electrical power to perform their function. Passive devices are exposed to indoor air by being “uncapped” or similarly activated, then left in place for a length of time, known as the measurement period.

Active devices, on the other hand, require an electrical power source. They are capable of charting radon gas concentration fluctuations throughout the course of a given measurement period (usually by producing integrated periodic measurements over a period of two or more days).

## Passive devices

**Activated charcoal adsorption devices (AC)** are passive devices, and the charcoal within these devices has been treated to increase its ability to adsorb gases. During the entire measurement period (typically two to seven days), the adsorbed radon undergoes radioactive decay.

Like all passive devices, the average concentration calculated is subject to error if the radon concentration in a room varies substantially during the measurement period. This device does not uniformly adsorb radon during the exposure period; as a result, these test kits are not true integrating devices. ACs must be promptly returned to the laboratory period using a mail service that guarantees delivery to the laboratory within no more than two days, but **preferably overnight**. The potential for any radon gas in the envelope to “leak” surpasses this urgency.

Different types of ACs are commercially available. A device commonly used contains charcoal packaged inside an air-permeable bag. Radon is able to diffuse into this bag where it can be adsorbed onto the charcoal. Another device is a circular container filled with activated charcoal. One side of the container is fitted with a screen that keeps the charcoal in but allows air to

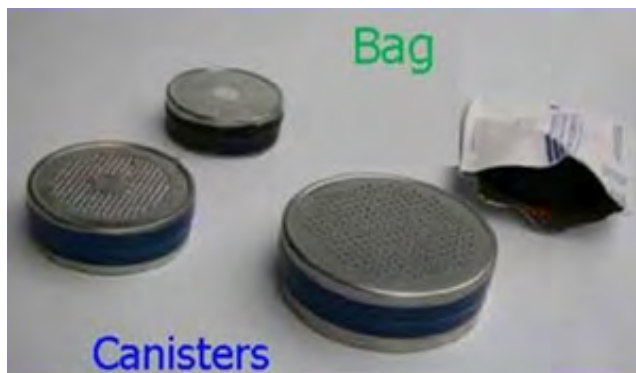

diffuse in the charcoal. Some of these devices' charcoal containers have a diffusion barrier over the opening to improve the uniformity of response to variations of radon concentration over time.

### How AC kits work

- Open the container in the area to be sampled.
- Radon gas enters into the charcoal and remains trapped along with subsequent radon decay products.
- At the end of the sampling period, seal the container and send it to the lab for analysis.
- The lab counts the amount of decay from the radon adsorbed to the charcoal on a gamma detector. The lab uses this information to calculate the radon concentration.

AC detectors are deployed from two to seven days, depending on design. Because charcoal allows continual adsorption **and** desorption of radon, this method does not give a true integrated measurement over the exposure time. Use of a diffusion barrier (usually included in the test kit) over the charcoal reduces the effects of drafts and high humidity.

### Advantages:

- Inexpensive
- Does not require power to operate
- Can be sent through the mail
- Can be deployed by anyone
- Accurate

### Disadvantages:

- Should be analyzed by a laboratory as soon as possible after removal from building
- Highly sensitive to humidity
- No way to detect tampering
- Results biased toward last 24 hours of deployment period

**Electret-ion chambers (EIC)** are also passive devices. They function as true integrating detectors measuring the average radon gas concentration. EICs take advantage of the fact that radiation is emitted from the decay of radon and radon decay products impart an electrical charge on the airborne particles that are released. These charged particles or ions are attracted to an electrostatically charged disc in the EIC chamber, which reacts to their presence by losing some of

its charge. The amount of charge reduction is directly related to the average radon concentration in the chamber.

EICs may be designed to measure for short periods (typically two to seven days) or for longer periods, up to one year. The type of electret and chamber volume determine the usable measurement period. The electret is removed from the chamber and its voltage is measured with a specialized reader both before and after the measurement period. The difference between the two voltage readings is used to calculate the average radon concentration.

### How they work:

- The plunger at the top is used to open and close the device. With the plunger open, the radon gas enters the main chamber through a filter, which prevents the entry of radon decay products (solids).
- The radon gas inside the chamber decays and creates electrostatically charged particles that are attracted to the charged Teflon disc. The charged particles (radon decay products) reduce the voltage on the disc by small amounts.
- The electret is removed from the chamber and its voltage is measured with a specialized reader both before and after the measurement period.
- The difference between the two voltage readings is used to calculate the average radon concentration.
- There can be both short-term and long-term electrets. These are commonly called ES (short-term) and EL (long-term). EL may be deployed for one to 12 months and ES may be deployed for two to seven days.

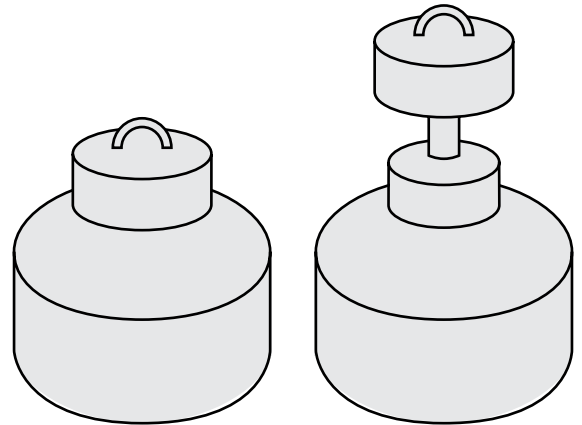

### Advantages:

- Results can be given immediately
- Does not require power
- Can be reused after reading the voltages

### Disadvantages:

- Sensitive to background radiation
- Sensitive to altitude
- Voltage measurements should be done at the same temperature
- Difficult to detect tampering

**Alpha track detectors** consist of a small piece of plastic or film encased in a container with a filter covered opening. Radon diffuses into the container and alpha particles emitted by radon and its decay products strike the detector and produce submicroscopic damage to the plastic. At the end of the measurement period, the detectors are returned to a laboratory. The damaged tracks are counted using a microscope or counting mechanism. The counted numbers of tracks are mathematically correlated to the radon concentration in air. These are most commonly used for long-term radon measurements three to 12 months in duration.

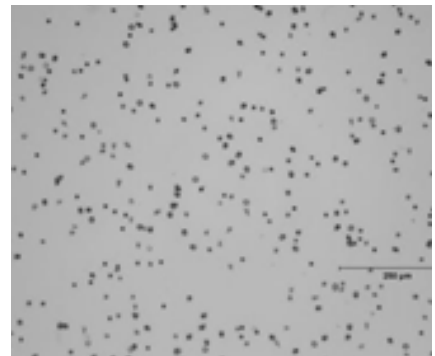
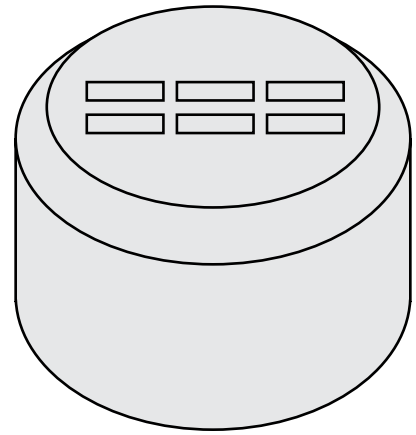

Microscopic scratches caused by radon decay products

## Active devices

Active devices include the continuous radon monitors (CRM), which include a power source. The device collects air samples either mechanically or passively and uses a detection monitor to read radon concentrations. CRMs have the highest accuracy and precision over short measurement periods.

An advantage of CRMs is they record radon levels (often in one hour increments). These levels usually vary over time – sometimes greatly. Users can then review that recording to pinpoint the times of day when radon is higher in a building. HVAC systems can then be adjusted to lower those levels when a building is usually occupied, as appropriate.

These devices are expensive to buy, require ongoing annual calibration and many require specialized training to use correctly. CRMs can be costly to use in a school, particularly for initial testing, when multiple devices are necessary to test many rooms simultaneously. [CRMs can also be rented so the renter doesn't directly incur calibration costs.]

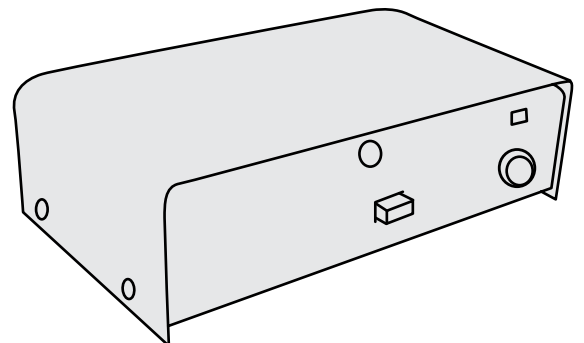
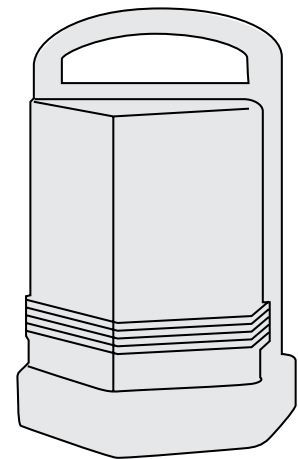

## Short- and long-term tests

**There are two ways to use radon test kits (passive and active) for radon testing:**

- **Short-term** — A short-term test is the quickest way to test for radon. In this test, the testing device remains in an area (e.g., schoolroom) for a period of between two and 90 days depending on the device.
  - » Activated charcoal (AC) devices, which are simple to operate and place without any assistance, may be used to conduct school screening measurements. Test kits may be purchased in a hardware store, department store or home improvement store, or ordered through the mail or Internet. They can be purchased in bulk at a discounted rate. Please note: AC kits require “closed-building conditions” before/during the test, per kit instructions.
  - » Electret-ion chamber devices are also simple to operate and place, but may be more costly to purchase and operate.
- **Long-term** — A long-term test remains in place for more than 90 days. A long-term test (e.g., a test conducted over the school year) will give a result that is more likely to represent the school year average radon level in a schoolroom. Long-term tests **do not** require closed building condition.
  - » Alpha track detectors are also simple to operate and place, but are slightly more expensive and measurement results take longer to obtain.

---

*Short-term passive testing devices are recommended for **initial** measurements of schools.*

---

## Measurement protocol/strategy

The short-term test is suggested to measure radon levels. In order to assure adequate test results, only use devices for a measurement period of at least 48 continuous hours when testing for radon in school buildings. The following steps should be taken:

### Step 1: Initial measurements

Initial measurements should be short-term measurements of between two and seven days. These measurements should be made in all frequently occupied rooms in contact with the soil, whether the contact is slab-on-grade, a basement, a room above a crawlspace or any combination. This provides a quick test of whether or not high radon concentrations are present. Short-term test kits should be placed during colder months (October through March, depending on geographical location).

- » The building should be assessed to determine the number of measurement devices needed. See the “Quality assurance procedures for a school radon measurement program” section on [page 31](#) for information on the total number of devices, including those needed for quality assurance purposes.
- » Frequently occupied rooms include classrooms, offices, conference rooms, computer rooms, gymnasiums, auditoriums, cafeterias and break rooms. All rooms should be tested simultaneously.
- » Do not test storage rooms, kitchens, bathrooms, stairways, hallways or elevator shafts.
- » A minimum of one detector test kit must be placed for up to every 2,000 square feet of open floor area. For example, a 3,500 square-foot gymnasium would require two test kits.
- » All teachers or frequent adult users should be aware that the room is being tested.
- » Schools shall only be tested for radon during periods when the HVAC system is operating normally.
- » **“Closed-building conditions,” as discussed in the “Radon Testing Process Guide” (see Appendix A), must be observed for short-term testing.**
- » In order to get the most accurate long-term test result in a timely manner, we recommend beginning short-term testing in early October. This will allow long-term testing, if needed, to be installed by early November and picked up at the end of the school year.

---

*Perform a follow-up measurement in every room where the initial test result is 4 pCi/L or greater.*

---



## Step 2: Follow-up measurements

If the results of a radon screening test in any frequently occupied room are found to be 4.0 pCi/L or greater, conduct follow-up measurements. The EPA and OHA recommend that follow-up testing of rooms 4.0 pCi/L or greater be conducted before any mitigation decisions are made. Follow-up testing should start quickly, ideally within one month of receiving initial test results.

Based on the results of a room's **initial** short-term test, the following steps should be conducted:

**If the result is less than 2.0 pCi/L**, Oregon Revised Statute 332.166-167 requires school districts to test again every 10 years.

**If the result is between 2.0 pCi/L and 4.0 pCi/L**, consider fixing (i.e., lowering) the radon in that room.

**If the result is from 4.0 pCi/L to 8.0 pCi/L**, perform a follow-up measurement of that room using a long-term test. This should be conducted over as much of a nine-month school year as possible, when the room is likely to be occupied. If that result is equal to or greater than 4.0 pCi/L, the radon in the room should be fixed (i.e., lowering).

**If the initial test result is equal to or greater than 8.0 pCi/L**, conduct a second short-term test and average its result with the result of the initial short-term test. If the average result of the two short-term tests is equal to or greater than 4.0 pCi/L, radon in the room should be fixed (i.e., lowering).

[A great difference in the results of the short-term tests may indicate a flaw in the testing process. Investigate and consider retesting. In situations where one of the test results is equal to or greater than 4.0 pCi/L: If the higher result is two or more times the lower result, repeat the test.]

All follow-up measurements should be made in the same locations and under the same conditions as the initial measurements (to the extent possible, including similar seasonal conditions and especially HVAC system operation). If follow-up measurements using short-term tests are done, be sure to maintain closed-building conditions. This will ensure that the two results are as comparable as possible.

The higher the initial short-term test result, the more certain you can be that a short-term test should be used rather than a long-term follow-up test. In general, the higher the initial measurement, the greater the urgency to do a follow-up test as soon as possible. For example, if the initial short-term measurement for a room is several times the radon action level (e.g., at or above 8.0 pCi/L or higher), immediately take a short-term follow-up measurement.

## Use of continuous radon monitors for rooms $\geq 4.0$ pCi/L after follow-up testing

CRMs may be used in these rooms to determine radon levels when the room is actually occupied. [See CRM discussion in “Types of radon measurement devices” on [page 21](#).] That may allow some fine-tuning of the room’s HVAC system to reduce those levels. Schools might consider collaborating to buy/rent a CRM, which group members could use for this purpose.

## How are results interpreted?

Procedures for analyzing test results from detectors, duplicates, blanks and spikes are detailed in the “Interpreting initial results” section on [page 37](#).

- **If the follow-up test is short-term, average the results of the initial test and the follow-up. If result is 4.0 pCi/L or above, The EPA recommends that the radon concentration in that room be reduced to below 4.0 pCi/L.**
- **If the follow-up test is long-term, and the result is 4.0 pCi/L or above, the EPA recommends that the radon concentration in that room be reduced to below 4.0 pCi/L.**

It is not recommended that schools use a single short-term test to determine whether to reduce radon levels, before consulting with a certified radon professional. A follow-up measurement to confirm an initial short-term measurement of 4 pCi/L or higher should be conducted before making such a decision. In addition, EPA studies have shown that the average of two such short-term measurements reduces the possibility of misrepresenting the average radon concentration.

## Is mitigation needed?

The need to mitigate will depend on radon levels found by follow-up measurements, if needed.

Oregon does not regulate or license radon mitigation professionals. The Oregon Radon Awareness Program does have a list of companies with at least one radon measurement technician on staff who has been certified by the National Radon Proficiency Program (NRPP) or the National Radon Safety Board (NRSB). That list is located at: <http://1.usa.gov/1nSvisi>.

Current listings of certified mitigation technicians by these two national non-governmental organizations can be found at [www.nrpp.info](http://www.nrpp.info) and [www.nrsb.org](http://www.nrsb.org). This list should be used for informational purposes only and is not intended to be an endorsement by the Oregon Health Authority of any measurement company. These organizations are not the only sources of radon services.

The professional may perform additional diagnostic testing and ultimately may make recommendations for mitigation. Diagnostics involve the evaluation of radon entry points and the identification of the appropriate radon reduction technique. Mitigation is the design and implementation of a radon reduction strategy.

While ORS 332.166-167 does not specifically require mitigation of elevated radon, both U.S. EPA and OHA strongly suggest that rooms with follow-up measurements above 4.0 pCi/L be mitigated. Very elevated radon concentrations and site-specific considerations may suggest a quicker response rate.

## What are the types of mitigation systems?

Schools and large commercial buildings are more complex than residential homes. Yet such intricacy may offer more options for reducing elevated radon. Like most other indoor air contaminants, radon can best be controlled by keeping it out of the building in the first place rather than removing it once it has entered.

It is likely impossible to reduce a school's radon to zero. Again, the goal of radon reduction is harm reduction.

Radon can be controlled through:

- HVAC systems. Adjustment to the heating, ventilation and air conditioning systems serving a room may reduce radon levels to below EPA's action level guideline of 4 pCi/L.
- Soil depressurization. A suction fan is used to produce a low-pressure field in soil under the building slab. This low-pressure field prevents radon entry by ventilating the gas outside before it has a chance to get drawn into the building.
- Building pressurization. Indoor/soil pressure relationships are controlled to prevent radon entry. More outdoor air is supplied than exhausted so the building is slightly pressurized compared to both the exterior of the building and the sub-soil area.
- Sealing entry routes. Seals are installed at major entry routes to minimize radon entry.
- Zone-specific ventilation. A building's crawlspaces, tunnels, conduits, vaults, etc. may be used to design a system that reduces its elevated radon.

**For new school buildings**, a cost-effective method to control radon is radon-resistant new construction (RRNC). Because a building's potential for elevated radon cannot be measured before it is constructed, specific components of a radon mitigation system (e.g., gravel layers, ventilation pipes) are installed while the building is under construction.

If, after testing, elevated radon is found in the finished building, a radon fan can easily be added and the system activated. Under current statute, RRNC is required in all public buildings (including schools) and residences built after April 1, 2013, in seven Oregon counties (Baker, Clackamas, Hood River, Multnomah, Polk, Washington and Yamhill).

**For existing buildings**, the most effective and frequently used radon reduction technique is adjustment of a building's HVAC system. This method directly influences radon entry by altering air pressure and dilution differences between the radon in the soil and building interior. Depending on the type and operation, an HVAC system can create positive or negative air pressure. Positive pressure can prevent radon entry, while negative pressure enhances radon entry. The positive pressure can be achieved through additional heating, cooling and/or dehumidification, along with enhanced routine operation and maintenance. A number of school districts across the country, upon finding elevated radon in just a few rooms in a school building, have lowered the radon levels in those rooms by altering the building's HVAC system.

At a certain point, however, such adjustments can reduce the effectiveness (and increase operational costs) of components in this system. Such ongoing operational costs may be greater than the upfront costs of active soil depressurization (ASD).

If adjustment of a building's HVAC system does not lower a room(s) elevated radon, a common radon reduction method is ASD. ASD is especially effective with higher levels of radon. ASD creates a lower pressure in the underlying soil to reverse the flow of air through a building foundation, thereby reducing radon entry. A series of pipes draw radon gas from underlying soil while an inline high suction fan is attached to these pipes to vent the soil gas from beneath the building foundation. ASD is accompanied by sealing radon entry routes, which improves radon removal efficiency and reduces energy costs. ASD, however, has no effect on general air quality within the building.

Radon typically enters the building from the soil through cracks and openings in the slabs and sub-structure. However, it is difficult, if not impossible, to seal every crack and penetration. Therefore, sealing radon entry routes is often used in conjunction with other mitigation techniques, and not considered a long-term solution by itself.

## Planning, costs and economies of scale in school radon measurement

It is important to consider the costs associated with radon testing (labor, test kit costs, shipping, etc.) as well as what is at stake in human health. School districts should consider two important points:

- **Planning is critical** — Testing schools for elevated radon is not difficult, but it requires coordination and planning. With so many moving parts, particularly around quality assurance measures, school radon measurement teams should have a well thought-out testing plan that accounts for shipping times, school calendars, lab schedules, etc. Poorly thought-out testing efforts can lead to inaccurate results and can be costly. For example, testing efforts in school districts in other states have led to invalid results (and thousands of dollars lost) because exposed test kits didn't get to testing laboratories in time due to poor planning.

By going through a well thought-out dry-run on paper, staff will likely be able to identify timelines, costs (staff time and test kit costs) and unforeseen barriers. Knowing these before testing begins may result in more accurate test results and decreased costs.

OHA recommends (but does not require) that school radon measurement teams use the tools (“Test Kit Location Floor Plan” and “Test Kit Placement Log”) found in the “Step-by-step guide for planning radon testing in Oregon schools” in Appendix D.

- **Roving School Radon Measurement Team** — School districts, particularly smaller ones, should consider having a **roving** School Radon Measurement Team that goes from school to school in the district. Neighboring districts might consider jointly funding such a team to cover all schools in the group. Groups of schools may want to jointly buy/rent a CRM. These are particularly useful in understanding when radon levels are at their highest (so that HVAC systems can be adjusted to lower those levels when the buildings are occupied, as appropriate).

While every school is a little bit different, the procedures for testing in schools are essentially the same. A team that tests many schools will likely accumulate experience and become more efficient in measuring each school. This decreases staff time needed to coordinate timelines, place test kits and analyze results. By joining forces, districts may also be able to buy test kits (and spiking services) in bulk.

# Quality assurance

Having accurate radon test results is important since mitigation can be expensive. For that reason, OHA strongly recommends that quality assurance (QA) measurements be taken to make sure that testing results are reliable. This requires the use of additional test kits.

For radon testing projects, “quality assurance” refers to maintaining the minimum acceptable standards of three concepts during the entire data collection process: precision, accuracy and bias. These are all defined below:

“**Precision**” refers to the closeness of two or more measurements to each other. In radon testing, the objective of precision is to see how close the results of two radon test kits are that have been placed side-by-side for the same measurement period. Test kits called “duplicates” are used for his purpose.

While some variation between the “detector” device and the duplicate kit paired with it is expected, an unusually large variation in the results of the two tests may indicate a systematic problem in the measurement process for a building. Using duplicates to determine precision is discussed in the “Quality assurance procedures for a school radon measurement program” section on [page 31](#).

“**Accuracy**” is defined as how close the measured value is to the actual value. In other words, were test kits on the site measuring anything other than the radon at the school site? In radon testing, test kits called “blanks” are used to determine whether the manufacturing, shipping, storage or processing has affected the accuracy of the testing process for a site. Using blanks to determine accuracy is discussed in the “Quality assurance procedures for a school radon measurement program” section on [page 31](#).

“**Bias**” is defined as amount of systematic error inherent to the testing process, including potential test kit defects and quality defects of the testing laboratory (i.e., the kit manufacturer to which the kit is returned after use for processing). Test kits called “spikes” are used to determine measurement laboratory and test kit accuracy. Using spikes to determine bias is discussed in the “Quality assurance procedures for a school radon measurement program” section on [page 31](#).

## Types of test kits used in quality assurance for radon testing

- 1. Duplicates:** Duplicates provide an indication of the precision of the measurement. Duplicates are test kits that are placed in the same location alongside the kits used as detectors for the same measurement period.

The number of duplicates should be 10 percent of the rooms to be tested at a school site.

A minimum of one duplicate per building is needed. [Round up if a fraction. For example, a school has 55 rooms to be tested. Ten percent of those equals 5.5 test kits. But the team should request six kits for spiking.]

- 2. Blanks:** Blanks can be used to determine whether the manufacturing, shipping, storage or processing of the test kit has affected the accuracy of the measurements. They are called blanks because they are placed alongside opened detectors but then immediately resealed. As a result, blanks should have results at or close to 0.0 pCi/L.

The number of blanks should be five percent of the rooms to be tested at a school site; round up if a fraction. A minimum of one blank per building is needed.

- 3. Spikes:** Spikes evaluate how accurately the detectors supplied by a radon testing laboratory measure radon and the accuracy of that lab's kit processing. Spike testing involves exposing kits to known levels of radon in a certified performance test chamber. Currently, there are two chambers (Bowser-Morner Inc. and Radon Measurement Lab) certified by AARST-NRPP (<http://aarst-nrpp.com/wp/test-chambers/>) to provide spiking services. Those spikes are returned to the School Radon Measurement Team, which sends them (unidentified) to the radon testing laboratory.

The number of spikes should be three percent of the rooms to be tested at a school site; round up if a fraction.

Developing a device placement and floor plan is recommended for each school building to be tested. The serial numbers and locations for devices placed on the site (detector, duplicate and blanks) should be included in the device log. The School Radon Measurement Team should retain the logs, but time and date data is copied to/sent along with the kits to the radon measurement laboratory.



## Quality assurance procedures for a school radon measurement program

Please read this **entire** section before starting testing. Some steps are time-dependent. All should be done as part of well-planned testing effort. (10)

1. As discussed above, a School Radon Measurement Team should calculate how many detector kits are needed. This number equals the number of regular rooms that are to be measured plus those kits required for larger rooms (2,000 square feet or larger). Larger rooms need one test kit per 2,000 square feet or portion thereof, so a 3,500 square-foot gymnasium needs two detector kits.
2. In addition to those detectors, kits for quality assurance (QA) purposes should be purchased in the following proportions: duplicate kits (a number equal to 10 percent of the rooms to be tested at a school site); blank kits (5 percent of the rooms to be tested at a school site); and spike kits (3 percent of the rooms to be tested at a school site). Note: Each building to be tested should have, in place, a **minimum** of one duplicate and one blank.

**Important:** Test kit percentages for QA are based on the number of **rooms** to be tested, **not** the number of detector kits to be used.

3. After determining the number of test kits (detectors, blanks, duplicates and spikes) needed for initial measurement of school site(s), kits should be purchased from one manufacturer (and be from one lot). It is most cost-effective to purchase in bulk.
4. Once the kits are received, team staff should **randomly** draw the kits needed for spiking (the 3 percent) from the boxes. The serial numbers of the kits should be recorded, noted as the kits being reserved for spike testing and set aside.
5. For radon measurements of a **single** school site:
  - a. Approximately two weeks before testing is to start, the team should contact a certified performance test chamber to discuss spiking services (<http://aarst-nrpp.com/wp/test-chambers/>). Team should inquire about and understand the chamber's schedule for spiking the kits and express mailing them back to the sender. A school's testing timeline may depend on that schedule.
  - b. Send kits to the certified performance test chamber for spiking. The chamber should return those spiked kits via overnight delivery to the team so that their arrival coincides with the end of the school's measurement period. Spikes can then be included in the same container as the detectors, blanks and duplicate kits (but not identified as spikes) and shipped overnight back to the radon measurement laboratory.



6. For radon measurements of **multiple school sites**:
  - a. Approximately a month before testing is to begin, the team should contact a certified performance test chamber (<http://aarst-nrpp.com/wp/test-chambers/>) to discuss the chamber's spiking schedule and arrange ongoing spiking services for the duration of the testing project.
  - b. With spiking service arrangements in place, the team should mail the kits designated for spiking (the 3 percent) to the chamber. Now the team has a bank of kits at the chamber waiting to be spiked. At the team's request (see above, "Quality assurance procedures for a school radon measurement program," step 5 on [page 31](#)), the chamber will spike the requested number of banked kits with a known amount of radon (spiked), and express mail them to the team along with documentation on that known level.
  - c. The team will know in advance the date that the devices (detectors, blanks and duplicates) deployed at a particular school site are to be picked up. The team should contact the chamber with which it has banked test kits for spiking and request that a specific number of spiked test kits be sent to a particular school site so their arrival **coincides** with the end of that school's measurement period. Spikes can then be included in the same container as the detectors, blanks and duplicate kits (but not identified as spikes) and shipped overnight back to the radon measurement laboratory.
7. In two to four weeks, the team will receive results for all the test kits analyzed. Please see "Interpreting initial results" on [page 37](#) for procedures to analyze and apply the test results.

# Radon testing process guide

The first step of conducting initial screening measurements is to identify rooms that have potentially elevated radon levels (e.g., levels of 4.0 pCi/L or greater) during the occupied school year.

1. As suggested, prepare a “**Test Kit Placement Log**” and a “**Test Kit Location Floor Plan**” for each school in which radon measurements are made. Use the school’s emergency escape map as the floor plan, since it usually provides the most accurate and up-to-date information.

Accurately record the test kit location on both a log and floor plan. See the sample “Test Kit Placement Log” and the “Test Kit Location Floor Plan” in Appendix D for reference.

2. Test kits or testing services must meet the current requirements of the national certifying organizations, National Radon Proficiency Program (NRPP, [www.nrpp.info](http://www.nrpp.info)) or the National Radon Safety Board (NRSB, [www.nrsb.org](http://www.nrsb.org)). Testing must follow the directions on the test kit.
3. You must determine the number of test kits needed to measure radon (detectors) by counting the number of appropriate rooms. One detector kit is used for each room that is 2,000 square feet or less. Use additional test kits for larger rooms. [See “What rooms should be tested?” section, [page 17](#).]
4. Add the test kits needed for quality assurance purposes to this number [see “Quality assurance procedures for a school radon measurement program” section on [page 31](#).]
5. Place test kits in all rooms in contact with the soil or located above a basement or a crawlspace that are frequently occupied by students and school staff. [See “Test Kit Placement Guide” in Appendix A.]
6. Ensure that testing occurs during when students and teachers are normally present (during weekdays).
7. In addition to placing detectors, provide additional test kits to serve as quality control measures (duplicate, blank and spike measurements). [See “Quality assurance” section starting on [page 29](#).]

Place kits designated as blanks and duplicates using the “Test Kit Placement Guide” in Appendix A.

Spike test kits are **not** physically placed on site, but are used for quality assurance purposes. Ordering spikes from a certified performance test chamber (and their delivery) should coincide as closely as possible with the date testing stops and detectors, duplicates and blanks are picked up so **all** kits can be mailed to the radon measurement laboratory. [See “Quality assurance measurements for a school radon measurement program” on [page 31](#).]

8. Note all test kits placed in the school site (detectors, duplicates and blanks) by their serial number on the “Test Kit Placement Log” and “Test Kit Location Floor Plan.”
9. Place test kits:
  - a. Where they are least likely to be disturbed or covered up;
  - b. At least three feet from doors, windows to outside or ventilation ducts;
  - c. At least one foot from exterior walls;
  - d. Between 20 inches and six feet from the floor;
  - e. Approximately every 2,000 square feet for large spaces (e.g., a 3,500 square-foot gymnasium would require two test kits).

Using the five-item placement protocol above, the school radon measurement team can simply **place the test kit on the teacher’s desk** or on a bookshelf, out of the way of students.

To prevent tampering (like at elementary schools), kits may be suspended from a wall or ceiling (using string and thumb-tack/tape). If they are suspended, they should be between 20 inches and six feet above the floor, at least one foot below the ceiling.

10. Test kits must **not** be placed:
  - a. Near drafts resulting from heating, ventilating vents, air conditioning vents, fans, doors and windows;
  - b. In direct sunlight;
  - c. In areas of high humidity such as bathrooms, kitchens or laundry rooms;

- d. Where they may be disturbed at any time during the test.
11. You must use short-term test kits under closed conditions (closed windows/doors except for normal exit/entry).
    - a. Closed conditions: Complete short-term tests under closed conditions in order to obtain more representative and reproducible results. Open windows and doors permit the movement of outdoor air into a room. When closed conditions in a room are not maintained during testing, outdoor air may dilute radon gas and result in a measurement that falls below the action level in a room that actually has a potential for an elevated radon level. Only test schools shall for radon when the HVAC system is operating normally.
    - b. All external doors should be closed except for normal use. Repair any structural and weatherization defects prior to testing.
    - c. Verify closed conditions when placing and retrieving test kits.
  12. Place short-term test kits during colder months (October through March) depending on geographical location.
    - a. Colder months: It is important to test under closed conditions to obtain meaningful results from short-term tests. As a result, schools should schedule testing during the coldest months when windows and exterior doors are more likely to be closed and the heating system is likely operating. This usually results in less intake of outside air. Studies of seasonal variations of schools' radon measurements found that short-term measurements may more likely reflect the average radon level in a room for the school year when taken during the winter heating season. Fortunately, this is when most schools are in session.
    - b. Check and document local weather forecasts prior to placing test kits. Do not conduct short-term measurements (between two and five days) during severe storms or periods of high winds. The definition of severe storm by the National Weather Service is one that generates winds of 58 MPH and/or three-quarter-inch diameter hail and may produce tornadoes.
  13. Place test kits during weekdays with HVAC systems operating normally.
    - a. Weekday testing: Do short-term (two to five-day) testing on weekdays. The actual length of time a kit is deployed depends on the manufacturer's instructions.

Suggested timeline:

Monday morning – Place kits (detectors/duplicates/blanks) per “Test Kit Placement Log” created for school. Record data, as needed, on log.

Thursday morning – Pick up kits, record as needed, ship with (previously requested & received) spiked test kits to radon measurement laboratory.

- b. Air conditioning systems that recycle interior air may be operated.
  - c. Window air conditioning units may be operated in a re-circulating mode, but must be greater than 20 feet from the test kit.
  - d. Ceiling fans, portable humidifiers, dehumidifiers and air filters must be more than 20 feet from the test kit.
  - e. Portable window fans should be removed or sealed in place.
  - f. Fireplaces or combustion appliances (except for water heaters/cooking appliances) may not be used unless they are the primary source of heat for the building.
14. If radon mitigation systems are in place in the school, they should be functioning.
15. Schools should avoid conducting initial measurements under the following conditions:
- a. During abnormal weather or barometric conditions (e.g., storms and high winds). If major weather or barometric changes are expected, it is recommended that the two- to five-day testing be postponed. EPA studies show that barometric changes affect indoor radon concentrations. For example, radon concentrations can increase with a sudden drop in barometric pressure associated with storms.
  - b. During structural changes to a school building and/or the renovation of the building's envelope or replacement of the HVAC system.

### Follow-up measurements

Follow-up testing (in rooms with initial short-term measurement of 4.0 pCi/L or higher) should start within one month after receiving the initial test results. Follow-up testing must be made in the same location in a room. Conducting follow-up testing using short-term methods should be done in the same conditions as the initial measurement. Follow-up testing using passive short-term test kits should follow the same quality assurance procedures and requirements (i.e., percentages of duplicates/blanks/spikes). Follow directions under “Radon Test Placement Protocol Checklist” and record test kit placement.

# Interpreting initial results

1. Review the results of the initial testing and highlight any results that are at or above 4.0 pCi/L.
2. For the detector kits that had duplicate kits paired with them, compare the results of the two kits by calculating the relative percent difference (RPD).

$$\text{Relative percent difference (RPD)} = \frac{\text{Initial result} - \text{duplicate result} \times 100\%}{\text{Average of both results}}$$

If results are:	Expected range	In control	Warning	Out of control
2.0–3.9 pCi/L	0–25%	0–49%	50–67%	> 67%
≥ 4.0 pCi/L	0–14%	0–27%	28–36%	> 36%

If a result over 4.0 pCi/L differs by 28 percent or more, the data quality should be questioned.

In this case, you should call the radon measurement lab to investigate the situation further. The room associated with the questionable duplicate may need to be retested. If the lab doesn't provide a satisfactory answer, a team representative should discuss it with a radon measurement professional.

3. Review the results of the blank test kits sent for analysis. Results should be very close to 0.0 pCi/L. If they are not, call the the radon measurement lab to investigate further. If unresolved, a team representative should contact a radon measurement professional.
4. Check to be sure that the spike results are accurate by calculating how close the measured value (i.e., detector kit result) is to the reference value (i.e., spike value reported back by certified performance test chamber). Calculate the relative percentage error (RPE) for each spike.

$$\text{Relative percentage error (RPE)} = \frac{(\text{Measured value} - \text{reference value}) \times 100\%}{\text{reference value}}$$

The result of each spike can then be put in one column or plotted on a chart.

## How to use spike testing results

The purpose of spike testing is to ensure that bias is not influencing a site's test results. Yet one spike result that's outside the control limit does not mean that the school site's test results are completely off. In general, one should look for a **trend** in the values in the percent difference column/table.

Relative percent error (RPE)	Expected range of variability	In control	Warning	Out of control
	Between +10% and -10%	Between +20% and -20%	Between +30% and -30%	Outside of +30% and -30%

A trend in RPE values that are more than  $\pm 30\%$  should be investigated.

In that case, the team’s storage, handling and kit placement should be reviewed. At the same time, the radon measurement lab should be contacted and the RPE result(s) discussed so that the lab can review its own procedures. A team representative should contact a radon measurement professional to discuss.

### Interpretation of follow-up test results

Perform the same quality assurance calculations done for initial testing. Questions about discrepancies in quality assurance results should be directed to a radon measurement professional.

### Report of results and distribution

ORS 332.166-167 requires that school districts make all test results available: to the district’s school board; the Oregon Health Authority (to post on its website) and to parents, guardians, students, school employees, school volunteers, administrators and community representatives at the school or district office or website.

### Radon measurement professionals

Questions about the quality assurance discrepancies listed above should be directed to a radon measurement professional.

Oregon does not regulate or license radon measurement professionals. The Oregon Radon Awareness Program has a list of companies with at least one radon measurement technician on staff certified by the National Radon Proficiency Program (NRPP) or the National Radon Safety Board (NRSB). That list is located at <http://1.usa.gov/1Vhijhx>.

Current listings of certified measurement technicians by these two national non-governmental organizations can be found at their respective websites, [www.nrpp.info](http://www.nrpp.info) and [www.nrsb.org](http://www.nrsb.org).

This list is for informational purposes only and is not intended to be an endorsement by the Oregon Health Authority of any measurement company. These organizations are not the only sources of radon services.

# After receiving results of follow-up testing

The EPA, OHA Oregon Radon Awareness Program and numerous non-governmental groups recommend that the school district take action to reduce the radon level in those rooms where the average of the initial and follow-up short-term kit results **OR** the result of the long-term kit used in follow-up is 4.0 pCi/L or more.

Although not required of school districts under ORS 332.166-167, it is recommended that school administration direct appropriate staff to adjust the building's HVAC system and then retest. If this doesn't reduce the radon below 4.0 pCi/L, school districts can hire a radon mitigation professional to reduce elevated radon levels identified through testing.

## When should periodic retesting be done?

Initial testing should be conducted in accordance with ORS 332.166-167 before Jan. 1, 2021. Because buildings age and ground beneath them settles, radon entry may increase due to cracks in the foundation. For that reason, ORS 332.166-167 requires that schools be tested once every 10 years regardless of initial testing results or whether mitigation was done.

Suggested times for retesting, in addition to that required under ORS 332.166-167, are as follows:

1. Current national guidelines (1) recommend that school buildings be re-tested every five years.
2. If radon mitigation measures have been implemented in a school, retest these systems as a periodic check to ensure that the radon mitigation measures are working. The EPA does not provide a specific interval, but **OHA recommends** that schools with radon mitigation measures retest every five years.
3. Retest after major renovations to the structure of a school building or after major alterations to a school's HVAC system. These renovations and alterations may increase radon levels within a school building.
4. If major renovations to the structure of a school building or major alterations to a school's HVAC system are planned, retest the school before initiating the renovation. If elevated radon is present, radon-resistant techniques can be included as part of the renovation.



Please direct questions to:

Oregon Radon Awareness Program

971-673-0440

[radon.program@state.or.us](mailto:radon.program@state.or.us)

[www.healthoregon.org/radon](http://www.healthoregon.org/radon)

# References

1. American National Standards Institute/American Association of Radon Scientists and Technologists. Protocol for conducting measurements of radon and radon decay products in schools and large buildings, 2014 [national radon standards].
2. U.S. Surgeon General. Surgeon general releases national health advisory on radon. 2005. U.S. Health and Human Services press release, Jan. 13, 2005 [cited 2016 May 9]. Accessed at URL: [www.adph.org/radon/assets/surgeon\\_general\\_radon.pdf](http://www.adph.org/radon/assets/surgeon_general_radon.pdf).
3. American Cancer Society. Cancer facts & figures 2015. American Cancer Society. Atlanta: American Cancer Society; 2015 [cited 2016 May 3]. Accessed at: URL: [www.cancer.org/acs/groups/content/@editorial/documents/document/acspc-044552.pdf](http://www.cancer.org/acs/groups/content/@editorial/documents/document/acspc-044552.pdf).
4. Siegel RL, Miller KD, Jemal A. CA: A cancer journal for clinicians. 2015 Jan; 65 (1): 5–29.
5. Field RW. Breathing easier: an informational radon video for physicians. [ND] [cited 2016 May 10]. Accessed at: URL: <http://canceriowa.org/BreathingEasier.aspx>.
6. National Research Council. Health effects of exposure to radon. 1999. Committee on Health Risks of Exposure to Radon (BEIR VI), Board on Radiation Effects Research, Commission on Life Sciences, National Research Council, National Academy Press, Washington, D.C.
7. Environmental Protection Agency. Radon measurement in schools revised edition. USEPA Air and Radiation (EPA 402-R-92-014) 1993 July.
8. Klepeis NE, Nelson WC, Ott WR, Robinson JP, Tsang AM, Switzer P, Behar JV, Hern SC, Engelmann WH. The national human activity pattern survey (NHAPS): a resource for assessing exposure to environmental pollutants. *J Expo Anal Environ Epidemiol* 2001 May–Jun;11(3):231–52.
9. Environmental Protection Agency. National residential radon survey: summary report. USEPA (EPA 402/R-92/011. 1992 October.
10. Ohio Department of Health Bureau of Environmental Health and Radiation Protection Radon Licensing Program. [Adapted from:] School radon testing checklist 2015 [cited 2016 May 10]. Accessed at: URL: [www.odh.ohio.gov/~media/ODH/ASSETS/Files/eh/school\\_environmental\\_health/schoolradontestingchecklist.pdf](http://www.odh.ohio.gov/~media/ODH/ASSETS/Files/eh/school_environmental_health/schoolradontestingchecklist.pdf).
11. Burkhart JF. Radon Measurement Lab (RML), 2015.

# Websites

School staff, parents and students may be interested in additional information on radon. The Oregon Radon Awareness Program suggests the following radon websites:

[Environmental Protection Agency \(EPA\) \[www.epa.gov/radon\]](http://www.epa.gov/radon)

EPA's main page is on everything radon.

[EPA's radon in schools page \[www.epa.gov/radon/radon-schools\]](http://www.epa.gov/radon/radon-schools)

[National Radon Program services \[www.sosradon.org\]](http://www.sosradon.org)

This EPA-funded program is nationally recognized leader in radon education.

[National Cancer Institute's radon page \[www.1.usa.gov/1qGOOtM\]](http://www.1.usa.gov/1qGOOtM)

[Oregon Field Guide: radon \[http://bit.ly/1SLRgWC\]](http://bit.ly/1SLRgWC)

This 12-minute episode, from Oregon Public Broadcasting, provides an excellent introduction on why elevated radon is a concern in Oregon.

[Oregon Health Authority's frequently asked questions on radon](http://www.healthoregon.org/radon)

[\[www.healthoregon.org/radon\]](http://www.healthoregon.org/radon)

In addition to FAQs, OHA's main radon page has information on radon risk in Oregon and how homes can easily be tested.

# Glossary

**Action level:** The designated measurements at or above which consumers should take action to reduce radon levels.

**Blanks:** Measurements made by analyzing unexposed (closed) detectors that accompanied exposed detectors to the field. School districts use blanks to assess if any change in analysis is caused by anything outside the immediate room conditions being tested. Background levels may be due to leakage of radon into the detector, detector response to gamma radiation or other causes.

**Carcinogen:** A dangerous substance that is directly involved in the contraction of cancer.

**Closed-building condition:** Keeping all windows and doors closed except for normal entry and exit, and not operating fans or other machines that bring in air from outside. Fans that are part of a radon-reduction system or small exhaust fans operating for only short periods of time may run during the test.

**Duplicates:** Duplicate measurements provide a check on the precision of the measurement result and allow the user to make an estimate of the relative precision. Large precision errors may be caused by detector manufacture or improper data transcription or handling by suppliers, laboratories or technicians performing placements. Precision error can be an important component of the overall error. The precision of duplicate measurements are monitored and recorded as quality records.

**Long-term test:** A radon testing kit that is designed for a long testing period usually in excess of 90 days.

**Mitigation:** A process used to remove high levels of radon from a home, residence, school or business.

**Picocuries per liter (pCi/L):** A unit of measurement. It specifies the decay in seconds within a volume of one liter of air.

**Quality assurance:** A process designed to produce test results that can serve as a standard.

**Radon:** A harmful gaseous radioactive decay product of radium.

**Short-term test:** A radon testing kit that is designed for a short testing period anywhere from a two- to 90-day period.

**Spikes:** Measurements used to assess the accuracy of a lab analysis and/or how accurately detectors supplied by a laboratory (i.e., test kit manufacturer) measure radon. Spikes are test kits that have been exposed to a known concentration of radon in a chamber approved by the National Radon Proficiency Program (NRPP) or National Radon Safety Board (NRSB). The process for completing this aspect of a radon measurement effort’s quality assurance/quality control plan is laid out in the “Radon Test Placement Protocol Checklist” in Appendix A.

# Appendix A: Radon test placement protocol checklist

**Note:** This document has been prepared to help schools and school districts conduct radon measurements in schools. The step-wise approach is aimed at helping school districts determine where to test, how many test kits are required, where to place test kits, and proper documentation of the process. This document is thus meant to be used as a general guideline, not a mandate. Each school will present a different situation. If specific questions or issues arise regarding testing in your school, contact the Oregon Radon Awareness Program at 971-673-0440 or email [radon.program@state.or.us](mailto:radon.program@state.or.us).

**Important:** Order all radon test kits for initial measurement at the same time. Kits should all be from the same manufacturing batch.

## Test Kit Placement Guide

Once the number of test kits is determined, they need to be placed in the frequently occupied rooms as identified in the “What rooms should be tested?” section on [page 17](#).

1. Be sure to check these items before placing the radon test kits:
  - Closed building conditions have been maintained in the building for 12 hours.
  - HVAC system is operating as it normally would when students and faculty are present.
  - Testing is being done during a time that students and faculty are present.
2. As detectors are placed in the rooms, determined thorough and accurate data needs to be recorded on the device log and floor plan (see samples in Appendix D).

Protocol for all test kits include the following. Be sure that each detector placed is:

- In a location where it will be undisturbed;
- Out of direct sunlight;
- Three feet from all doors and windows;
- Four inches from all other objects;

- At least one foot from all exterior walls;
- At least 20 inches to 6 feet from the floor;
- Out of direct air flow from vents;
- Four feet from the heat source.

School measurement teams in other states simply place the test kit on the teacher's desk or out of the way of students on a bookshelf.

3. Specific protocol for duplicate measurements. If the test kit you are placing is a duplicate measurement also be sure to:
  - Place duplicate (side-by-side) test kit four to five inches away from test kit for that room
4. Specific protocol for blank measurements. If the test kit you are placing is a blank measurement, also be sure to:
  - Unwrap blanks and open, but then immediately close and reseal them.
  - Place the test kit next to the detector kit(s) for the room four to five inches away.
5. Specific protocol for spiked test kits.
  - Arrange for the spiked test kits to arrive back from the Certified Performance Test Chamber to the School Measurement Team as close as possible to the day that kits are retrieved from the school. [See "Quality assurance procedures for a school radon measurement program" on [page 31](#).]
6. Testing period.

The test kits should be left out no less than 48 hours but no more than seven days. [It's best to follow test kit manufacturer's instructions for more specific recommendations.] It's best if devices are left in place for four days to ensure optimum results.

Many schools place short-term kits on Monday morning and pick them up on Thursday morning.

Retrieving kits. Once the testing period has ended, all test kits placed at a school site (detectors, duplicates and blanks) need to be retrieved. This should be done on the same date. Complete the data sheet when retrieving detectors.

- Record the ending date and time that the kits were picked up per the “Test Kit Placement Log” [Appendix D].
- Record ending information on the test kit package (if required).

7. Prepare and mail all kits.

- Follow the manufacturer’s instructions to seal and prepare test kits to be mailed to the lab.
- Include those spiked kits (not identified as such) in the same box(es) as other kit types.
- Mail all test kits (detectors, duplicates, blanks, spikes) to the radon measurement laboratory specified on the test kit. Use a mail service that guarantees delivery to the laboratory within two days at maximum, but **preferably overnight**.



# Appendix B: Signage for school radon measurement

Below is a sign that that school radon measurement teams may use, as needed, to let school staff, parents and students know that measurement for elevated radon in the school is taking place.

## DO NOT TOUCH! RADON TEST IN PROGRESS

This is a screening test for the Sample School District #123. The radon detector should not be disturbed. Windows should remain closed and the radon detector will be picked up on \_\_\_\_\_.

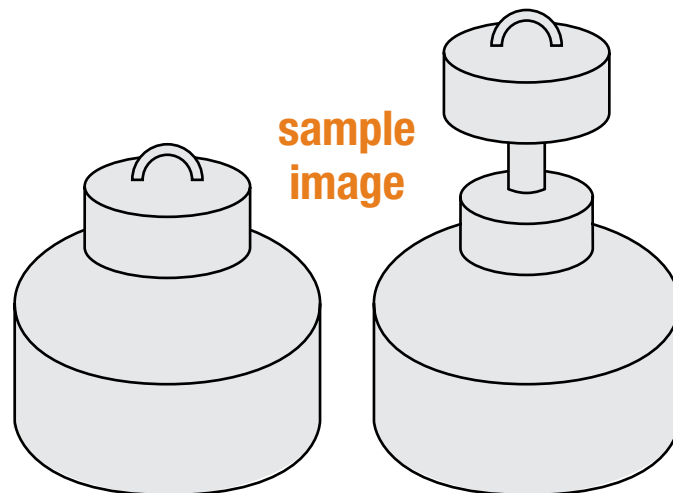

The Sample School District #123 is testing for radon. Radon is a colorless, odorless, naturally occurring radioactive gas that comes from uranium in the soil and can cause lung cancer. The surgeon general has warned about the health risk from exposure to radon in indoor air. The Surgeon General urged Americans to test their homes because radon is the leading cause of lung cancer for non-smokers in the United States and breathing it over prolonged periods can present a significant health risk. The U.S. Environmental Protection Agency (EPA) estimates that approximately 21,000 lung cancer related deaths occur annually in the United States with about 275 of those in Oregon.

Because of the danger of radon, every occupied school building in all Oregon school districts shall be tested every 10 years for radon per ORS 332.166-167.

For questions about this test, contact: \_\_\_\_\_

# Appendix C: Memo to parents and staff about radon measurement

Before radon measurement begins, schools may want to notify parents and school staff of the effort. Below is an example memo that can be customized.

## [EXAMPLE of a memo to be sent to school staff and parents before testing begins]

To: \_\_\_\_\_ Date: \_\_\_\_\_

From: Principal or Superintendent

Re: Radon testing

An important step is being taken to ensure that the buildings of [insert name of school] are healthy and safe.

This is to notify you that initial testing for elevated radon at [insert name of school] will be conducted starting [insert date]. Under a 2015 Oregon law (ORS 332.166-167), Oregon schools must be initially tested for elevated radon on or before Jan. 1, 2021.

The radioactive gas, radon, is the number-one cause of lung cancer among non-smokers, according to EPA estimates. Elevated radon is found naturally in soil across the country and under all types of structures (including homes).

To test for elevated radon at [insert name of school], small devices will be placed in each of the occupied rooms that are in contact with the ground starting [date]. These devices will be picked up on [date]. Test results will be available at the district office on or around [approximate dates].

The test devices look like [describe: 1) for example, a small black cylinder (also known as an alpha track) about 1-1/2 to 2 inches across; 2) for charcoal adsorption: cardboard envelope packet; 3) etc. A picture can be inserted here]. Devices may be placed in somewhat hidden locations, where possible. Please do not tamper with or move test kits, and keep exterior windows and doors closed (except for normal entry/exit) during the testing period.

While occupants may be exposed to elevated levels of radon in schools, current data from the United States Environmental Protection Agency (EPA) suggests radon exposure at home is the number-one source of radon exposure for most people. The EPA and the Oregon Health Authority (OHA) recommend that **all** homes, regardless of location and type, be tested.

Please see OHA's Frequently Asked Questions about radon, including information on the health effects, at [www.healthoregon.org/radon](http://www.healthoregon.org/radon). Information on how homes can be tested easily and inexpensively is also found at this website. You can request printed information on radon by contacting OHA's Radon Awareness Program at 971-673-0440 or [radon.program@state.or.us](mailto:radon.program@state.or.us).

If you have further questions or concerns regarding radon testing at [insert name of school], please feel free to contact [name, such as health and safety coordinator] at [phone or email].

Thank you, in advance, for your cooperation.

# Appendix D: Step-by-step guide for planning radon testing in Oregon schools

Per ORS 332.166-167, Oregon school districts shall develop a plan for testing schools under their jurisdiction for elevated levels of radon. They shall submit it to the Oregon Health Authority on or before **Sept. 1, 2016**.

Below is a recommended step-by-step guide for planning for radon testing at a specific school site. It's intended to be used with the other information in this document.

By going through well thought-out “dry-run” on paper, staff (e.g., school radon measurement teams) will likely be able to identify timelines, costs (staff time and test kit costs) and unforeseen barriers. Knowing these, before testing begins, may result in more accurate test results and decreased costs.

## 1. Identify rooms to be tested

ORS 332.166-167 specifies that “at a minimum, any frequently occupied room in contact with the ground or located above a basement or a crawlspace” should be tested.

Examples of such rooms include offices, classrooms, computer rooms, conference rooms, gyms, auditoriums, cafeterias and break rooms. This does not mean storage rooms, bathrooms, stairways, hallways, kitchens or elevator shafts.

Staff should procure a copy of the school’s emergency escape map. It can be used as the floor plan, since it usually provides the most accurate and up-to-date information. The map can be used to identify the frequently occupied rooms at a particular school site. As discussed below, that map can also be used to indicate which test kit types will go in which room.

Make sure all rooms in the building floor plan are individually labeled; create labels for them if they are not.

## 2. Determine the number of test kits needed.

- a) Count all frequently occupied rooms, as defined in ORS 332.166-167.

At the end of section 2a) you should have a rough list of rooms that need to be tested.

\_\_\_\_\_Number of rooms

- b) Determine if any of the rooms selected are larger than 2,000 square feet.

If YES, how many?

Determine the number of test (detectors) kits needed to test the entire school site:

\_\_\_\_\_ (Total number of rooms after section 2a).

\_\_\_\_\_ (Number of rooms over 2,000 square feet).

\_\_\_\_\_ (Number of rooms over 4,000 square feet).

\_\_\_\_\_ (Number of rooms over 6,000 square feet).

**TOTAL** \_\_\_\_\_ Number of detector kits needed to test the school site

### 3. Determine the number of quality control measurements needed

- a) Determine the number of **duplicate** measurements that need to be deployed during measurement. Rooms to be tested x 0.10 (10%) = \_\_\_\_\_  
[NOTE: Round up to the next whole number. Remember, a minimum of one duplicate kit per building.]
- b) Determine the number of **blank** measurements that need to be deployed during measurement. Rooms to be tested x 0.05 (5%) = \_\_\_\_\_  
[NOTE: Round up to the next whole number. Remember, a minimum of one blank kit per building.]
- c) Determine the number of **spike** measurements that need to be deployed during measurement. Rooms to be tested x 0.03 (3%) = \_\_\_\_\_  
[NOTE: Round up to the next whole number.]

### 4. Determine total number of test kits needed to perform all required tasks.

\_\_\_\_\_ Number of detector kits determined in Section 2.

\_\_\_\_\_ Number of duplicate tests determined in Section 3a.

\_\_\_\_\_ Number of blank tests determined in Section 3b.

\_\_\_\_\_ Number of spike tests determined in Section 3c.

**TOTAL** \_\_\_\_\_ **Number of test kits needed to test the school site**

### 5. Use a “Test Kit Location Floor Plan” to create a “Test Kit Placement Log(s)”

The school radon measurement teams can use a template of the school’s emergency escape plan to decide in which rooms the different types of test kits (detectors, blanks and duplicates) will be placed. These documents will guide the planning of a radon testing effort as well as the actual testing itself.

The school floor plan (see example below) is used to create “Test Kit Placement Log(s)” [see example on [page 54](#) and template on [page 57](#)] for the school, which indicates where the detectors, duplicates and blanks are to be placed when initial testing of the school for elevated radon begins.

**Important:** Because each building on a school site should have a minimum of one detector, one duplicate and one blank, a separate “Test Kit Placement Log” should be created for each building on the school site.

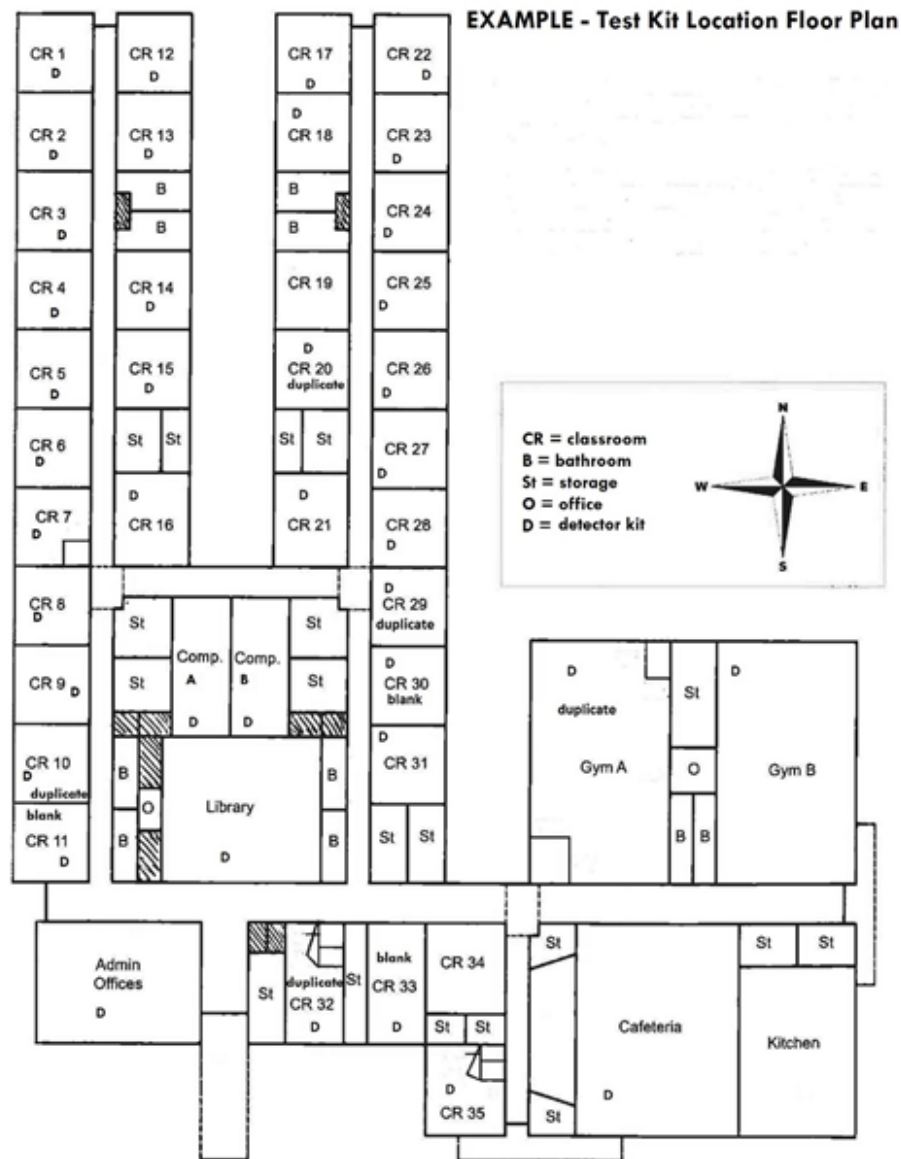

## Test Kit Placement Log Example

An example of the “Test Kit Placement Log” is on [page 54](#). It is based on the example “Test Kit Location Floor Plan” on [page 52](#). The log created for a school will be used for both planning the placement of test kits and recording data when testing of the school actually takes place. A blank “Test Kit Placement Log” (see [page 57](#)) can be used, along with the “Test Kit Location Floor Plan” template, found on [page 56](#).

**Directions:** Using a school’s “Test Kit Location Floor Plan,” please indicate in the log’s room description column the rooms that will have detectors (D), blanks and duplicate test kits. These should be selected per the guidance in the “What rooms should be tested?” section ([page 17](#)) and the “Quality assurance procedures for a school radon measurement program” section on [page 31](#) of this protocol. On the far right of the log, please indicate the “Type of test” (for that row).

[Although the “Test Kit Placement Log” has rows reserved for the 10 percent of rooms at a school site where duplicates should be placed (yellow/lighter shading), and for the 5 percent of rooms where blanks should be placed (gray/darker shading), these are for the team’s convenience. The selection of rooms for duplicates and blanks should be at random. Remember, there needs to be a minimum of one duplicate and blank per building.]

**Stop.** For the purposes of planning radon measurement at a school site, this is all that’s needed.

The remaining fields in the log will be filled out when testing of the school actually begins.

[Regarding the remaining fields: “Canister serial #” is the unique identification number found on each test kit; “Date and time opened” and “Date and time closed” refer to the actual moments when kits are placed and activated to begin measuring the radon in the room (and then stopped). This information, when reported to the radon measurement laboratory, helps it adjust its equipment for an accurate analysis of the test kit. **Note:** Staff who will actually conduct testing may be identified when testing actually begins]

If you have questions, please contact the Oregon Radon Awareness Program at

971-673-0440 or [radon.program@state.or.us](mailto:radon.program@state.or.us).

[www.healthoregon.org/radon](http://www.healthoregon.org/radon)

## Sample Test Kit Placement Log

**Name and physical address of school being tested:** South Elementary – ## Street, Salem, OR 97304

**Building:** Main building      **Radon testing contact at school:** Peter Progeny, 503-724-3135

**Name of individuals performing testing:**

Sammy Sampleton (Logger); Rosie Radon (Placer)

Room description (per floor plan)	Canister serial #	Date opened	Time opened	Date closed	Time closed	Type of test D = detector kit
CR1	100135	11/7/2016	6:00 am	11/10/2016	6:30 am	D
CR2	100137	11/7/2016	6:02 am	11/10/2016	6:37 am	D
CR 3	100139	11/7/2016	6:04 am	11/10/2016	6:40 am	D
CR 4	100140	11/7/2016	6:05 am	11/10/2016	6:44am	D
CR 5	100141	11/7/2016	6:06 am	11/10/2016	6:47 am	D
CR 6	100142	11/7/2016	6:07 am	11/10/2016	6:50 am	D
CR 7	100143	11/7/2016	6:08 am	11/10/2016	6:56 am	D
CR 8	100144	11/7/2016	6:9 am	11/10/2016	6:59 am	D
CR 9	100145	11/7/2016	6:11 am	11/10/2016	7:03 am	D
CR 10	100146	11/7/2016	6:13 am	11/10/2016	7:07 am	D
Same as above	100147	11/7/2016	6:13 am	11/10/2016	7:10 am	Duplicate
CR 11	100148	11/7/2016	6:14 am	11/10/2016	7:15 am	D
Same as above	100149	11/7/2016	6:14 am	11/10/2016	7:23 am	Blank
CR 12	100150	11/7/2016	6:16 am	11/10/2016	7:27 am	D
CR 13	100151	11/7/2016	6:17 am	11/10/2016	7:30 am	D
CR 14	100153	11/7/2016	6:19 am	11/10/2016	7:35 am	D
CR 15	100154	11/7/2016	6:20 am	11/10/2016	7:43 am	D
CR 16	100155	11/7/2016	6:22 am	11/10/2016	7:47 am	D
CR 17	100156	11/7/2016	6:23 am	11/10/2016	7:49 am	D
CR 18	100157	11/7/2016	6:24 am	11/10/2016	8:03 am	D
CR 19	100158	11/7/2016	6:25 am	11/10/2016	8:07 am	D
CR 20	100159	11/7/2016	6:26 am	11/10/2016	8:10 am	D
Same as above	100160	11/7/2016	6:27 am	11/10/2016	8:15 am	Duplicate
CR 21	100161	11/7/2016	6:28 am	11/10/2016	8:23 am	D
CR22	100162	11/7/2016	6:30 am	11/10/2016	8:27 am	D

[Adapted from Burkhart, 2015]

(example log continued)

Room description (per floor plan)	Canister serial #	Date opened	Time opened	Date closed	Time closed	Type of test D = detector kit
CR 23	100163	11/7/2016	6:31 am	11/10/2016	8:27 am	D
CR 24	100164	11/7/2016	6:32 am	11/10/2016	8:30am	D
CR 25	100165	11/7/2016	6:37 am	11/10/2016	8:37 am	D
CR 26	100166	11/7/2016	6:39 am	11/10/2016	8:40 am	D
CR 27	100167	11/7/2016	6:40 am	11/10/2016	8:41 am	D
CR 28	100168	11/7/2016	6:41 am	11/10/2016	8:43 am	D
CR 29	100169	11/7/2016	6:44 am	11/10/2016	8:45 am	D
Same as above	100170	11/7/2016	6:46 am	11/10/2016	8:46 am	Duplicate
CR 30	100171	11/7/2016	6:48 am	11/10/2016	8:47 am	D
same as above	100172	11/7/2016	6:49 am	11/10/2016	8:49 am	Blank
CR 31	100173	11/7/2016	6:49 am	11/10/2016	8:49 am	D
CR 32	100174	11/7/2016	6:49 am	11/10/2016	8:49 am	D
Same as above	100175	11/7/2016	6:51 am	11/10/2016	8:52 am	Duplicate
CR 33	100176	11/7/2016	6:53 am	11/10/2016	8:52 am	D
same as above	100177	11/7/2016	6:54 am	11/10/2016	8:55 am	Blank
CR 34	100178	11/7/2016	6:55 am	11/10/2016	8:57am	D
CR 35	100179	11/7/2016	6:56 am	11/10/2016	8:59 am	D
Computer A	100182	11/7/2016	7:04 am	11/10/2016	9:15 am	D
Computer B	100183	11/7/2016	7:05 am	11/10/2016	9:18 am	D
Gym A	100184	11/7/2016	7:06 am	11/10/2016	9:20 am	D
Gym A	100185	11/7/2016	7:10 am	11/10/2016	9:24 am	D*
Same as above	100186	11/7/2016	7:11 am	11/10/2016	9:30 am	Duplicate
Gym B	100187	11/7/2016	7:14 am	11/10/2016	9:32 am	D
Gym B	100188	11/7/2016	7:15 am	11/10/2016	9:35 am	D
Admin. offices	100189	11/7/2016	7:30 am	11/10/2016	9:37 am	D
Cafeteria	100190	11/7/2016	7:38 am	11/10/2016	9:42am	D

\*Gym A is 2,800 square foot space, so has two detector kits. But because duplicates, like other QA kits, are determined by the number of rooms in the building, only one the detector kits is paired with a duplicate.



## Test Kit Location Floor Plan Template

Name and physical address of school being tested:

Radon testing contact at school:

### School's Floor Plan

# Test Kit Placement Log (11) template

Name and physical address of school being tested:

Building: \_\_\_\_\_ Log page: \_\_\_\_\_ of \_\_\_\_\_ for school.

Radon testing contact at school: \_\_\_\_\_

Name of individuals performing testing: \_\_\_\_\_

\_\_\_\_\_ (Logger);

\_\_\_\_\_ (Placer of Test Kits)

Room description (per floor plan)	Canister serial #	Date opened	Time opened	Date closed	Time closed	Type of test D = detector kit
						D
						D
						D
						D
						D
						D
						D
						D
						D
						D
						D
						D
						D
Same as above						Duplicate
						D
Same as above						Blank
						D
						D
						D
						D
						D
						D
						D
						D
						D
						D
						D
						D
						D
						D
						D
						D
Same as above						Duplicate

(Use additional copies of this page for each building with frequently-used rooms at school site, as needed.)

# Appendix E: Frequently asked questions about radon and schools

1. Does radon cause headaches, eye irritation or sick-building syndrome? *No.*
2. Do children have a greater risk of cancer from radon exposure?  
*Children usually are more sensitive to environmental pollutants. However, no current data concludes that children are more at risk than adults from radon exposure.*
3. Is there a hazard from touching/being near the radon test kit?  
*No, although kits should be kept away from very young children (toddlers) so they don't eat or chew on them.*
4. Do building materials emit radon?  
*The primary source of radon in a building or home is from the soil underneath it. However, a few building materials such as granite, concrete, gypsum board (sheet rock), bricks and field stone may emit small amounts of radon gas. This is rarely the case because most of these materials are very dense. This means that if there is radon-producing radium in these materials, only a small amount of the radon gas near the surface ever makes it out into the environment.*
5. Should testing be delayed if the school is planning major renovations to the building or the HVAC system?  
*Initial and follow-up tests should be conducted prior to major HVAC or building renovations. Testing can show if a radon mitigation system needs to be installed as a part of renovation. Testing must also be done after renovation.*
6. Should upper floors of a school or building be tested? Does this mean that upper floors never have elevated levels?  
*Upper floors may indeed have elevated levels of radon. However, measurements in ground floor rooms are likely to be a good indicator of radon levels for all floors.*
7. In schools with a basement level (below ground level), the first floor is often built at ground level. It is, therefore, in contact with the soil along its outside edge. Should this floor be tested?  
*This floor appears to have limited contact with the soil. However, the outside rooms may have openings permitting radon entry and should be tested if they are frequently occupied. ORS 332.166-167 requires testing of all frequently occupied rooms in contact with the soil or above a basement or crawlspace.*

8. **Nearby homes and schools have reported no elevated levels of radon. Should we still test?**  
*Yes, radon levels vary with geology, building structure, HVAC systems, etc. The only way to know if radon is present is to test. ORS 332.166-167 states school buildings should be tested every 10 years; current national guidelines (ANSI/AARST, 2014) recommend that school buildings be re-tested every five years (or whenever there is significant renovation or change to a building's HVAC system).*
9. **What are the costs of radon testing in schools?**  
*The cost may depend on the number of rooms to be tested and the type of test kit used. The average cost of radon testing in Oregon schools is approximately \$10 per tested room. This assumes schools purchase short-term test kits in bulk and that school staff perform the testing.*
10. **If a room's short-term initial test result is very high (e.g., above 100 pCi/L), should a follow-up measurement be taken?**  
*Yes, follow-up measurements, even if the initial ones are high, are recommended before making any further decisions.*
11. **Should a room be retested if there is evidence the test has been moved or tampered with in any way? Yes.**
12. **How do you place radon test kits in large, open spaces such as cafeterias, gymnasiums or auditoriums?**  
*Test kits may be hung from the ceiling and or wall using string and masking/duct tape. Be sure to hang them per the "Test Kit Placement Guide" in Appendix A.*
13. **How do we test partitioned classrooms?**  
*Classrooms with movable partitions should be individually tested.*
14. **Can you test during unusual weather conditions (heavy rain, snow or wind)?**  
*Avoid testing during these conditions.*
15. **Should we take quality assurance duplicates and blanks during the follow-up tests?**  
*Yes, per the "Quality assurance" section, starting on [page 29](#). However, there are generally fewer samples taken for follow-up testing.*
16. **When two devices (duplicates) are placed in a room during initial testing, which measurement result is taken as the test result?**  
*Both tests are recorded, but the average is taken as the test result.*
17. **What should be done if a device is picked up late or handled incorrectly?**  
*Handle all test kits in accord with manufacturer's instructions. If there is any discrepancy or problem, the device's serial number should be recorded and noted to the laboratory doing the analysis. Include in the log the actual time device was picked up and a brief description of how the device was mishandled.*



This document can be provided upon request in an alternate format for individuals with disabilities or in a language other than English for people with limited English skills. To request this publication in another format or language, contact the Oregon Radon Awareness Program at 971-673-0440, 711 for TTY, or email [radon.program@state.or.us](mailto:radon.program@state.or.us).